

**FUJITSU RX7300  
LASER PRINTER  
USER'S GUIDE**

The contents of this manual are subject to change without prior notice. All rights reserved.

The following is a trademark of Hewlett Packard Corp.:

**LaserJet+**

The following is a trademark of Epson America Corp.:

**FX 80**

The following is a trademark of Xerox Corp.:

**Diablo 630**

## PREFACE

This Guide is a combined reference manual and tutorial for the **Laser Printer**. It contains information about the **Laser Printer**, a description of all features, and step-by-step instructions for operation of all functions.

The **Laser Printer User Guide** is written for the non-technical person who must use the latest in printer technology. It approaches each function from a "how-to" perspective that promotes immediate and confident use of any printer feature.

## FEDERAL COMMUNICATIONS COMMISSION RADIO FREQUENCY INTERFERENCE STATEMENT

This equipment generates, uses, and can radiate radio frequency energy and if not installed and used in accordance with the instruction manual, may cause interference to radio communications. It has been tested and found to comply with the limits for a Class A computing device pursuant to Subpart J of Part 15 of FCC Rules, which are designed to provide reasonable protection against such interference when operated in a commercial environment. Operation of this equipment in a residential area is likely to cause interference in which case the user at their own expense will be required to take whatever measures may be required to correct the interference.

**NOTE:**

The length of the power cord must be ten feet or less.

**NOTE:**

An unshielded plug or cable may cause radiation interference. The printer is designed for use with a properly shielded interface cable. A non-shielded interface cable must not be used. The shield must be connected directly to the chassis of the printer. The cable length must be 10 feet or less for the Centronics parallel interface. The cable length for the RS232 serial interface must be 50 feet or less.

# TABLE OF CONTENTS

## Preface

## How To Use This Guide

### One Introduction

1.1	Touring Your Laser Printer	1-3
1.2	Printer Module	1-4
1.3	Printer Controller	1-5
1.4	Operator Panel	1-6
	Setup Mode	1-7
	Printing Mode	1-8
1.5	Parallel or Serial Interface Port	1-12
1.6	Fontcard (IC) Cards and Slots	1-13
1.7	Facedown Paper Stacker/Jogger Unit	1-14
1.8	Paper Input Cassette	1-15
1.9	Second Cassette Module (Optional)	1-16
1.10	Large Capacity Hopper (Optional)	1-17

### Two Setting Up

2.1	Checking the Printer Environment	2-1
2.2	Unpacking	2-2
2.3	Checklist for Components	2-7

## Three Installation

3.1	Installing the Printer Components	3-1
	Installing the Photoconductor Drum	3-2
	Installing the Developer Unit	3-6
	Installing the Paper Cassette	3-10
	Installing the Face Down Stacker	3-12
	Installing the Cables	3-13
	Installing the Output Paper Tray	3-15
3.2	Installing the Font and Emulation Cards	3-16
3.3	Installing Optional Paper Sources	3-18
	Installing the Second Cassette Module	3-18
	Installing the Large Capacity Hopper	3-19

## Four Using the Control Panel

4.1	Overview	4-1
4.2	Quick-Start Tutorial	4-2
4.3	Control Panel Layout	4-5
	Indicator Lights	4-6
	SETUP Keys	4-6
	Error Reset Key	4-7
	Clear/Print Key	4-8
	Arrow Keys	4-9
	SET Key	4-9
	LCD Status/Menu Display Screen	4-10
4.4	Laser Printer Modes	4-11
	Printer Mode	4-11
	Setup Mode	4-12

---

4.5	Laser Printer Menus	4-13
4.6	Menu Selection and Set	4-17
4.7	MENUS	4-21
	Main Menu Options	4-22
	PRINT	4-22
	MACRO	4-24
	SELFTTEST	4-27
	HEX DUMP	4-28
	EXIT	4-28
4.8	I/F (Interface )Menu	4-30
	RS232 and CENT	4-30
	BAUD	4-31
	FORMAT	4-32
	PROTO (Protocol)	4-34
4.9	EMUL (Emulations) Menu	4-36
4.10	PAPER (Device) Menu	4-38
4.11	FONTS Menu	4-40
4.12	PAGE Menu	4-42
4.13	BITMAP Menu	4-46
4.14	IC Font Card Tutorial	4-47
<b>Five</b>	<b>Printing</b>	
5.1	Overview	5-1
5.2	Preparation and Setup	5-1
	Page Orientation	5-1
	Effective Print Area	5-4
5.3	Printer Emulation and Control Codes	5-5

**Six      Fonts****Seven    Maintenance**

7.1	General Printer Maintenance	7-1
	Charger	7-1
	Front Cover	7-2
	Carrier Station	7-2
	General Maintenance Schedule	7-3
7.2	Replacing the Toner Cartridge	7-4
7.3	Storage and Treatment of Paper	7-9
7.4	Replacing the Photoconductor Drum	7-10

**Eight    Problems and Solutions**

8.1	Overview	8-1
8.2	Paper Jamming Problems	8-2
8.3	Clearing Paper Jams	8-3
8.4	Print Quality Degradation	8-4
8.5	Laser Printer Error Messages and Conditions	8-5



**Appendices**

<b>A</b>	<b>Physical Specifications</b>	<b>A-1</b>
<b>B</b>	<b>Functional Specifications</b>	<b>B-1</b>
<b>C</b>	<b>Supplies and Accessories</b>	<b>C-1</b>
<b>D</b>	<b>Printer Emulation Control Codes</b>	<b>D-1</b>
	<b>LaserJet+ Control Codes</b>	<b>D-2</b>
	<b>Diablo 630 Control Codes</b>	<b>D-8</b>
	<b>Epson FX-80 Control Codes</b>	<b>D-14</b>
	<b>Extended Commands</b>	<b>D-22</b>
	<b>Raster Graphics (HP)</b>	<b>D-34</b>
<b>E</b>	<b>Status and Error Messages</b>	<b>E-1</b>
<b>F</b>	<b>Printer Options</b>	<b>F-1</b>
<b>G</b>	<b>Serial and Parallel Pinouts</b>	<b>G-1</b>

## FIGURES

1.1	Laser Printer	1-2
1.2	Laser Printer Module	1-4
1.3	Laser Printer Control Panel	1-6
1.4	Control Panel Setup Keys	1-7
1.5	Set Key	1-8
1.6	Control Panel Printing Keys	1-9
1.7	Control Panel LED Indicators	1-10
1.8	Control Panel 16-Character LCD Status Display	1-11
1.9	Laser Printer Ports	1-12
1.10	Laser Printer Font Card Slots	1-13
1.11	Laser Printer Font Card	1-13
1.12	Face-Down Paper Stacker/Jogger Unit	1-14
1.13	Paper Input Cassette	1-15
1.14	Second Cassette Module	1-16
1.15	Optional Hopper Unit - Front View	1-18
1.16	Optional Hopper Unit - Back View	1-19
2.1	Removing Locking Plastic Clips	2-3
2.2	Removing Box Top and Cutting the Foil	2-4
2.3	Removing Plastic Clips and Packing	2-5
2.4	Printer and Accessories Box	2-6
3.1	Precharger, Drum, and Carrier Station Lever	3-2
3.2	Removing the Drum Spindle Cover	3-3
3.3	Removing the Drum From the Box	3-4
3.4	Inserting the Drum	3-5
3.5	Developer Unit Cross-section	3-6
3.6	Magnetic Roller Drive Gear	3-7
3.7	Inserting the Developer Unit	3-8
3.8	Pushing the Lock Lever	3-9
3.9	Handling the Paper	3-10
3.10	Inserting the Paper into the Cassette	3-11
3.11	Face Down Stacker	3-12

3.12	RS232C or Centronic Interface Cable	3-13
3.13	Power Cable	3-14
3.14	IC Card and Card Slot	3-16
3.15	Second Cassette Module	3-18
3.16	Large Capacity Hopper with Printer	3-19
4.1	Laser Printer Control Panel	4-5
4.2	Control Panel Menus Part 1	4-14
4.2	Control Panel Menus Part 2	4-15
4.3	Current Environment Settings Report	4-23
5.1	Portrait and Landscape Orientation	5-1
5.2	Effective Print Area	5-3
7.1	Removing the Toner Cartridge	7-4
7.2	Shaking the Toner Cartridge	7-5
7.3	Removing the Plastic Seal	7-6
7.4	Replacing the Toner Collector Bottle	7-7
7.5	Replacing the Oil Felt	7-8
8.1	Paper Route	8-1

**TABLES**

5.1	Paper Dimensions	5-4
-----	------------------	-----



# HOW TO USE THIS GUIDE

This section of the **Printer User Guide** contains the following :

- **GUIDE ORGANIZATION**
- **GUIDE FORMAT**

For those who wish to become familiar with the **Laser Printer** immediately, the **GUIDE** contains a **Quick-Start** section. For those who wish more details, descriptions of the printer and its features and functions are discussed in subsequent sections. Text is mixed with frequent illustrations and both flow charts and step-by-step procedures are provided for describing functions and operations.

## Guide Organization

The organization of the text in this Guide allows for both tutorial and reference use. It is recommended that you review this sub-section to understand the organization of the **Guide**. The following is an overview and a contents summary for this **Guide**:

### **Preface**

States the purpose of the Guide and identifies the reader.

### **How To Use The Manual**

Briefly summarizes Guide organization, listing chapter contents briefly, and providing Guide definitions.

## **Chapter One Introduction**

Introduces the printer and its software with illustrations.

## **Chapter Two Setting Up**

Provides a checklist for the printer environment and for all printer components, including step by step procedures with illustrations on unpacking the printer.

## **Chapter Three Installation**

Step by step procedures for installing the printer components and optional paper sources.

## **Chapter Four Operation**

Provides a Quick-Start section for experienced users, and describes the Control Panel indicators and keys, and the Printing menu options

## **Chapter Five Printing**

Step-by-step procedures for printing preparation and setup, including a table of printer commands and their meanings.

## **Chapter Six    Fonts**

A section describing the fonts available with the printer and step-by-step procedures for using fonts and for adding font cards in the printer

## **Chapter Seven    Maintenance**

Provides a Table or checklist for routine maintenance including:

- Toner cartridge replacement
- Routine cleaning
- Adjusting print density

## **Chapter Eight    Problems and Solutions**

Provides a Table with *Problem* and *Solution* categories for minor error correction. Included are:

- Paper loading and changing problems
- Print quality problems
- Hardware errors

## Appendices

- A Physical Specifications
- B Functional Specifications
- C Supplies and Accessories
- D Printer Emulation Control Codes
- E Error Messages
- F Printer Options
- G Pinouts

## Index

## Guide Format

This section of the manual describes the format used in the Guide, consisting of graphics, illustrations and specialized headings that set off reference text for easy use.

Graphics and special formatting have been used in the Guide to bring certain text passages to your attention:

- Whenever possible, figures, illustrations, and screen displays appear on the same page where they are first mentioned. If they are not located on the same page, then they are placed on the next available page.
- **Bold** lettering within text is used in this Guide to emphasize System prompts, responses, or displays. Normally, this type of text is also separated by a new text line and indented.



- A **Note** is text within a centered box indicating important information that should be called to your attention.
- A **Caution** is text within a centered box indicating that the equipment may be damaged if the instructions are not followed.



**One Introduction**

1.1	Touring Your Laser Printer	1-3
1.2	Printer Module	1-4
1.3	Printer Controller	1-5
1.4	Operator Panel	1-6
	Setup Mode	1-7
	Printing Mode	1-8
1.5	Parallel or Serial Interface Port	1-12
1.6	Fontcard (IC) Cards and Slots	1-13
1.7	Facedown Paper Stacker/Jogger Unit	1-14
1.8	Paper Input Cassette	1-15
1.9	Second Cassette Module (Optional)	1-16
1.10	Large Capacity Hopper (Optional)	1-17



# 1 INTRODUCTION

The Laser Printer User Guide introduces you to the latest in laser printer technology, meeting the demands of today's industry-wide networking and multi-user environments. The Laser Printer combines speed, flexible configurations and ease of use. At a speed of 18 pages per minute, the Laser Printer is rated to print 25,000 to 50,000 sheets per month compared to a maximum of 3,000 to 5,000 pages typical of other desktop laser printers.

This heavy volume printer accommodates one 250-sheet paper cassette and an optional 250-sheet second cassette. A face down stacker provides neat, collated, stacked output - with each job offset to permit rapid separation. An optional large capacity input hopper, holding up to 1,000 sheets, is also available.

The Laser Printer prints on a wide variety of paper, including labels, letterhead stationery, and transparency film. The print controller provides multiple resident printer emulations, including HP LaserJet+™, Epson, FX80, and Diablo 630™. This printer also has seven resident fonts: Courier 10 (Upright and Italic), Prestige Elite 12 ( Upright and Italic), Times New Roman PS (Upright and Italic), and Line Printer (Upright only).

The toner cartridge is rated at an average of 6,000 pages per cartridge and is user-changeable.

For quick expansion of fonts, including logos and signatures, IC (Font) Cards are available to easily insert into the three IC card slots located on the upper right-hand side of the Laser Printer. Also available is an IC font card for HPGL (7475A) pen plotter emulation.

This chapter describes the Laser Printer (Figure 1.1) and related peripheral units such as the Hopper and the Stacker.

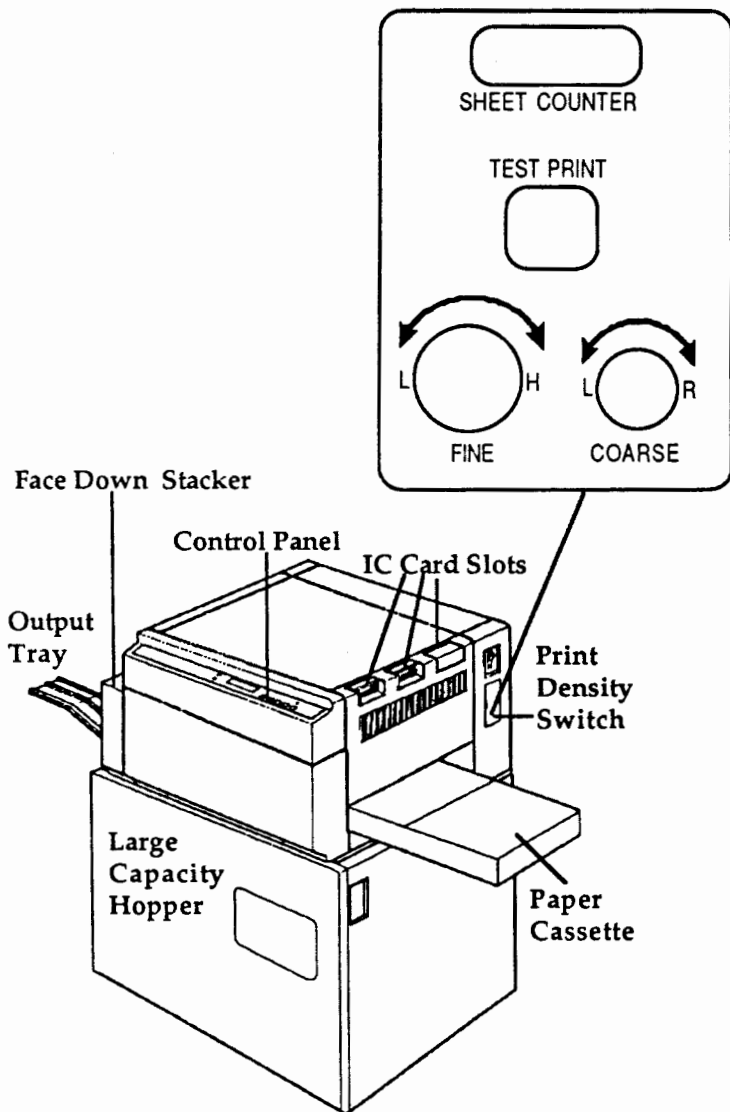

Figure 1.1 Laser Printer

## **1.1 Touring Your Laser Printer**

The Laser Printer includes the following:

- Printer module
- Printer Controller
- Control Panel with the following:
  - Setup Mode Keys
  - Printer Mode Keys
  - Printer LED Indicators
  - 16-character LCD Display
- Parallel or Serial Interface Port
- Three Font/Emulation Card (IC) slots
- One Facedown paper Stacker unit
- One paper cassette input unit
- One second input paper cassette module (Optional) \*
- One large-capacity input hopper unit (Optional) \*

\* Only one of these options can be used at any one time.

Each Laser Printer part is briefly described on the following pages.

## 1.2 Printer Module

The printer module consists of a laser optical system, a photoconductor drum, and a toner delivery system that prints optical images on paper.

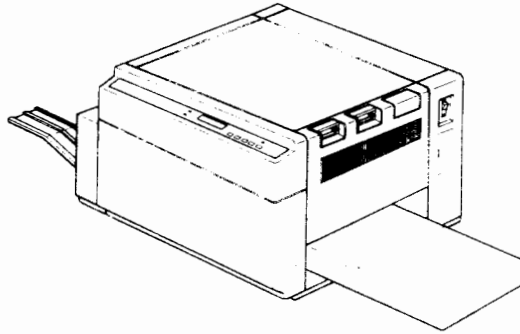

**Figure 1.2 Laser Printer Module**



Your printer scans a photoconductor drum with a laser beam that is modulated by video signals, creating electrostatic images of characters. These electrostatic images are converted into a toner image. Next, an electrical charge is applied. The paper attracts the toner image from the drum, and the image is then transferred to the paper.

Heat and pressure are applied by a heat roller in the fusing station to fix the transferred toner image to the paper. The printed page then passes into the output tray. Finally, the drum is cleaned to prepare its surface for printing the next page. The process is a continuous one, allowing high quality printing to continue uninterrupted.

### **1.3 Printer Controller**

The Printer Controller controls the front Control Panel operation and physical interfaces to the printer; i.e. RS232C and Centronics. The controller contains a microprocessor that

- Supports up to two megabytes of RAM.
- Emulates HP LaserJet+, Diablo 630, and Epson FX80 printers.
- Supports RS232C and Centronics protocols.
- Supports additional fonts and printer emulations via IC card inserts.

The controller microprocessor subsystem consists of address and data buses, address decoders and processor control signals.

## 1.4 Control Panel

The Control Panel consists of the following:

- **Five Printing and Setup Keys**
  - Two setup keys
  - Error Reset Key
  - Clear Print Key
  - Set Key
  
- **Three LED Indicators**
  - Power
  - Check
  - Online
  
- **16-character LCD Status Display**

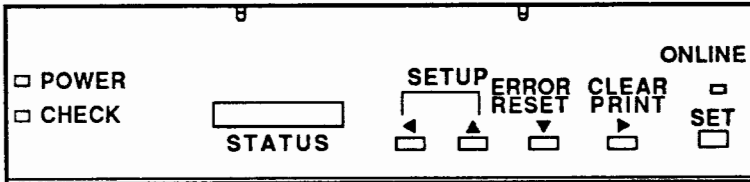

Figure 1.3 Laser Printer Control Panel

The Control Panel provides two modes of operation:

- **Setup Mode**
- **Printing Mode**

## **SETUP MODE**

Setup Mode allows you to select and set printer options by using a combination of Setup Keys, Control Panel keys, and Printer menu options. The Setup Mode uses two Setup Keys.

### **Setup Keys**

The two leftmost Setup Keys on the Control Panel are pressed simultaneously to enter Setup Mode. The keys can only be used when the printer is in an idle or offline state.

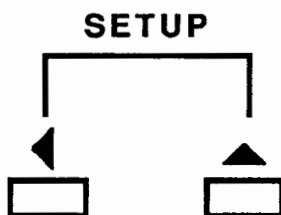

**Figure 1.4 Control Panel Setup Keys**

## Set Key

The **Set Key** is used to set the printer menu options as displayed on the LCD Status Panel.



Figure 1.5 Set Key

## PRINTING MODE

Printing Mode allows you to change the printer operation environment through the use of three Control Panel Keys.

### Printing Keys

**Error Reset Key** Press this key to recheck all printer conditions. If error conditions are found, they will be displayed on the LCD Status panel. The key is normally used after an error condition has been cleared by the operator (i.e., paper jam). It is only active when the printer is in an idle state. This key also resets the View IC Card (fonts) function if an IC font card has been installed..

**Clear Print Key (Form Feed Key)** Press this key to execute a form feed if the document's last page is still in the printer buffer. Normally, this key is used to print the remaining pages of a document when a form feed instruction or command has not been included in the document format. The key is only active when the printer is in an idle state; it is, however, active whether the printer is online or offline.

*(Online) Set Key* Changes the online/offline status of the printer when pressed. A green LED Online indicator is on when the printer is online.



**Figure 1.6 Control Panel Printing Keys**

### Three LED Indicators

*Power Indicator* When this **amber** LED indicator is ON, the printer has power. When the amber LED is not lighted, the printer is OFF.

*Check Indicator* When this **red** LED indicator is ON, a printer error condition is indicated. When it is OFF, the printer is in normal operating mode.

*Online Indicator* When this **green** LED indicator is ON, the printer is online. When it is OFF, the printer is offline.



Figure 1.7 Control Panel LED Indicators

## **16-Character LCD Status Display**

The Printer Status Display allows you to view the printer menus containing the following menu selections:

- **MAIN MENU OPTIONS**
  - PRINT
  - MACRO
  - SELFTEST
  - HEXDUMP
  - EXIT
  
- **SETUP MENUS**
  - I/F TYPE
  - EMUL
  - PAPER
  - SYSTEM FONTS
  - PAGE
  - BITMAP

Please refer to the Operations section for detailed information on these menu selections.



**MENUS**

**STATUS**

**Figure 1.8 Control Panel 16-character LCD Status Display**

## 1.5 Parallel or Serial Interface Port

Your printer has been factory-configured with either an RS232C (Serial) or Centronics (Parallel) interface port. This port is located on the far left-hand side next to the port for an additional paper handling device. (See Figure 1.9)

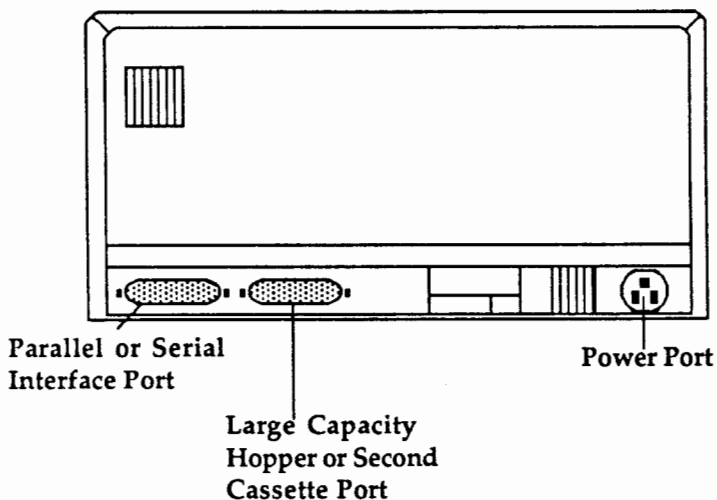
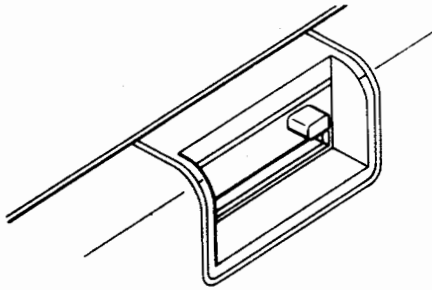

Figure 1.9 Laser Printer Ports



## 1.6 IC Cards and Slots

The printer contains three slots that accept IC cards providing downloadable fonts and alternative emulations to the printer. Figure 1.10 illustrates the location of these slots. Figure 1.11 illustrates an IC Card.



**Figure 1.10 Laser Printer Font Card Slots**

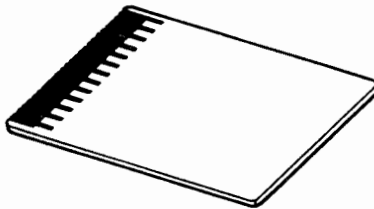

**Figure 1.11 Laser Printer Font Card**

## 1.7 Face Down Paper Stacker/Jogger Unit

A face-down stacker/jogger provides neat, collated, stacked output with job offset capabilities to permit rapid separation of different print jobs.

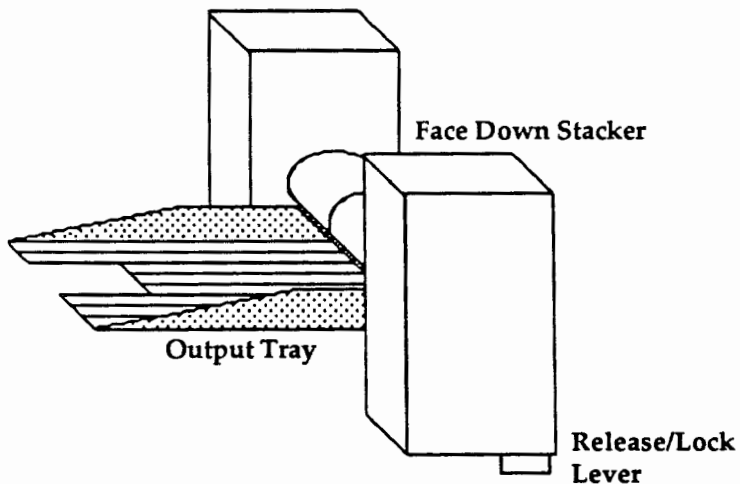
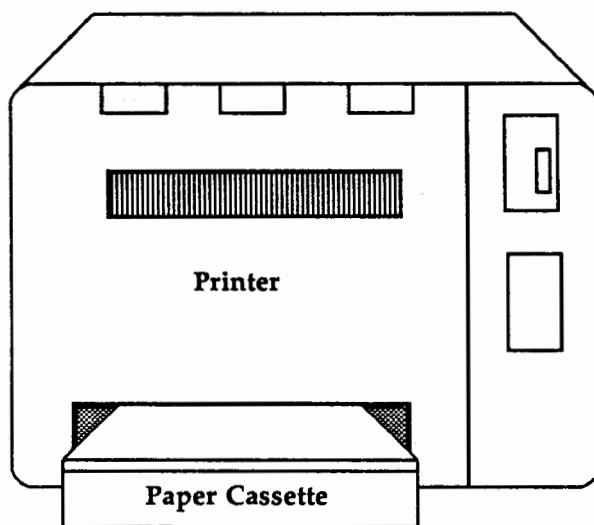

Figure 1.12 Face-Down Paper Stacker /Jogger Unit

## 1.8 Paper Input

A letter-sized paper cassette (Figure 1.13) comes with the printer. Three optional sized cassettes are available: A4 size, B4 size and Legal size cassettes. Each cassette has a capacity of up to 250 sheets.



**Figure 1.13 Paper Input Cassette**

## 1.9 Second Cassette Module (Optional)

The second cassette module has the capacity for up to 250 sheets of paper and is connected to, and placed directly under, the Laser Printer Module.

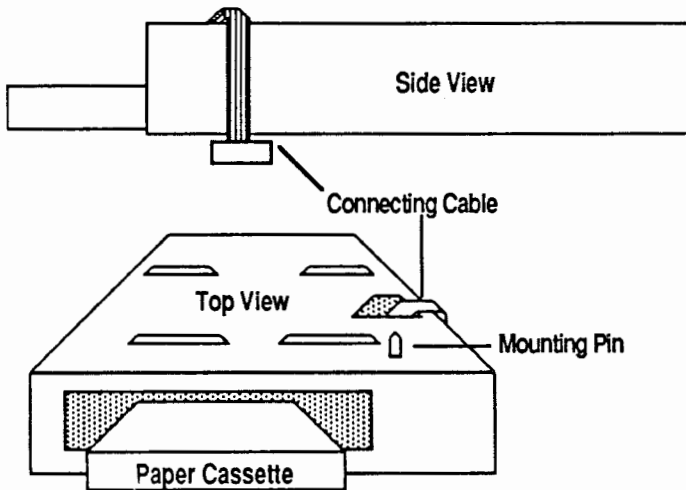

Figure 1.14 Second Cassette Module

## 1.10 Large Capacity Hopper (Optional)

The Large Capacity Hopper unit has the capacity for up to 1,000 sheets of paper and is connected to, and placed directly under, the Laser Printer module. This optional unit allows high volume, multi-user printing. The Hopper front door is opened to allow access to the paper loading platform. The platform automatically lowers for paper loading when the door is opened. Use the green handle on the front of the Hopper paper tray to pull the tray forward.

**NOTE:**

Be sure to remove the shipping bracket before turning on the large capacity hopper. The shipping bracket is the metal plate and two screws securing the paper loading platform. Also, always reinstall the shipping bracket when transporting the large capacity hopper.

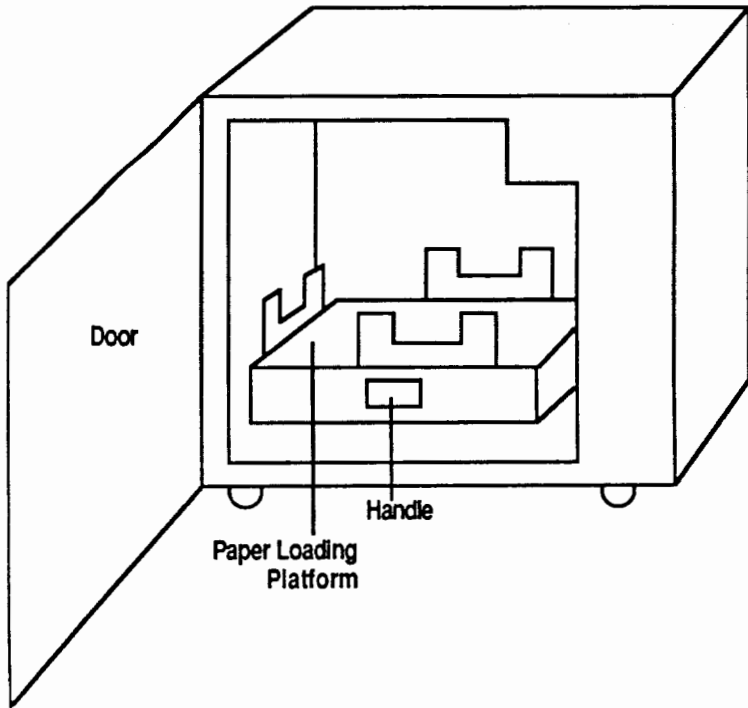
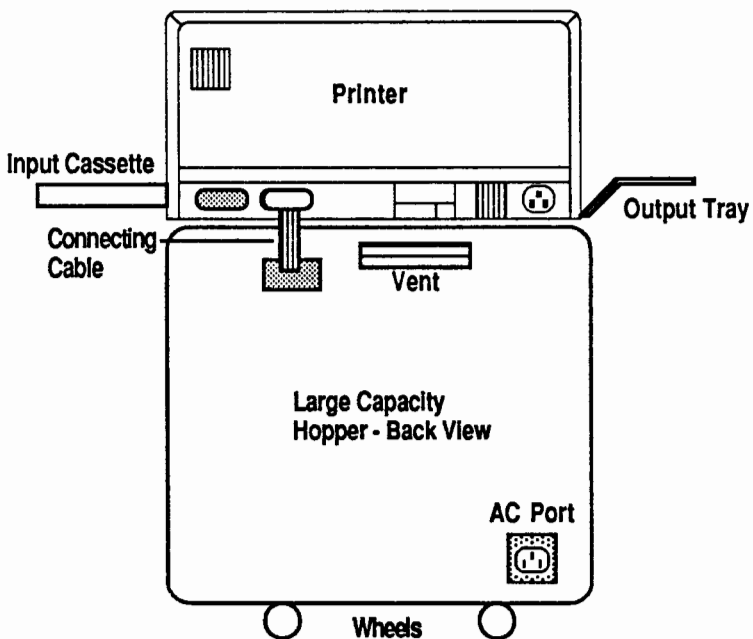

Figure 1.15 Optional Hopper Unit - Front View



**Figure 1.16 Optional Hopper Unit - Back View**





## **Two     Setting Up**

2.1	Checking the Printer Environment	2-1
2.2	Unpacking	2-2
2.3	Checklist for Components	2-7



## 2 SETTING UP

This chapter describes the environment necessary for the Laser Printer to operate efficiently, the procedures for unpacking the printer upon arrival, and also provides a check list of all the Laser Printer unit components.

### 2.1 Checking the Printer Environment

The Laser Printer performs most effectively if certain environmental requirements are met. Please observe the following procedures in the location where you unpack and install your laser printer.

- Install the printer on a level surface.
- Place the printer in a well-ventilated room.
- Place the printer away from direct sunlight.
- Do not expose the printer to high temperature or humidity. Ideal temperatures range from 50° F to 95° F or 10° C to 35° C. Ideal humidity is between 20% and 80%.
- Do not use magnets or magnetized materials near the printer.
- Avoid using a power cable longer than the power cable supplied with the printer.
- Avoid sharing power outlets with equipment that emits noise or causes power degradation.

## 2.2 Unpacking

The Laser Printer and its components are delivered in two boxes. The larger box weighs more than 100 lbs, so it is important that you have someone help you with the unpacking. The large box contains the printer, accessories, and drum/developer. The smaller box contains the face down stacker.

If you have ordered a second cassette module or a large capacity hopper, it is shipped in a separate box.

**NOTE:**

When you are unpacking your printer, remember to retain all the packing materials and the boxes in a storage area. If the printer or printer components require a return to your dealer, the packing materials are to be re-used.

### What You Do ... Procedure Steps

1. Place the large box on a large flat surface.

2. Remove the locking plastic clips holding the box top to the bottom platform. Squeeze the sides of the clips and pull them out. There are two locking plastic clips on the front and rear sides, and three on each side of the box. There should now be three open holes in each side and two open holes in the front and rear of the box top.

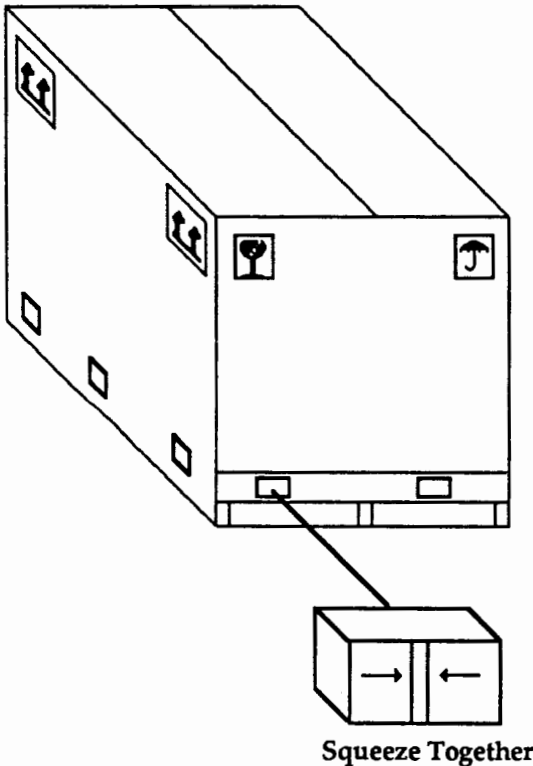

Figure 2.1 Removing Locking Plastic Clips

3. Lift off the box top. If the two smaller boxes are not covered with foil, proceed to step 7. If they are covered with foil, proceed to step 4 .
4. With a mat knife or Exacto knife, cut along the foil close to the bottom near the platform.

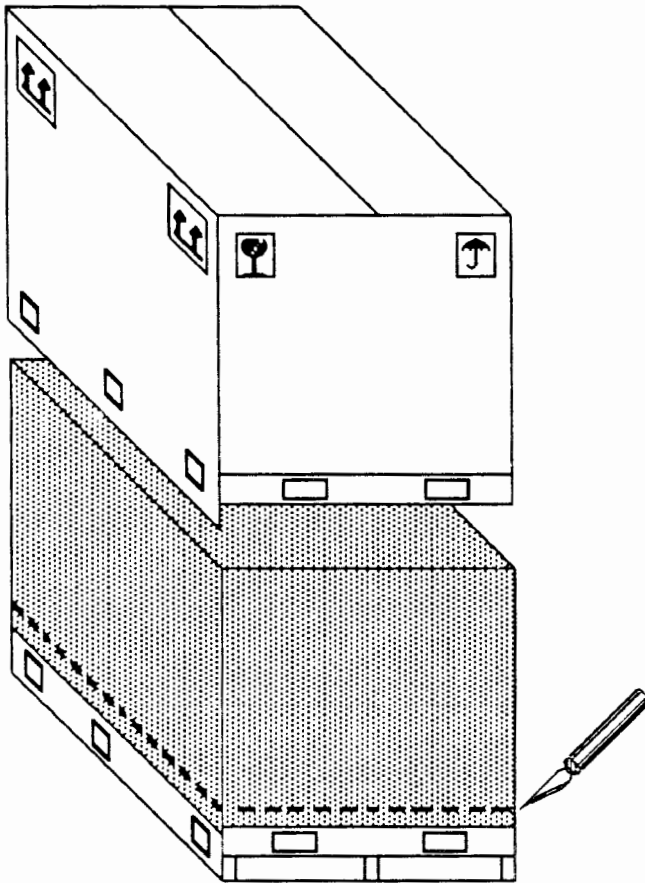

Figure 2.2 Removing Box Top and Cutting the Foil

5. Lift the foil off the two boxes.
6. With a mat knife or an Exacto knife, cut along the side of the white packing foam in front of the printer box. Remove the packing material.
7. Remove the locking plastic clips from the printer box.

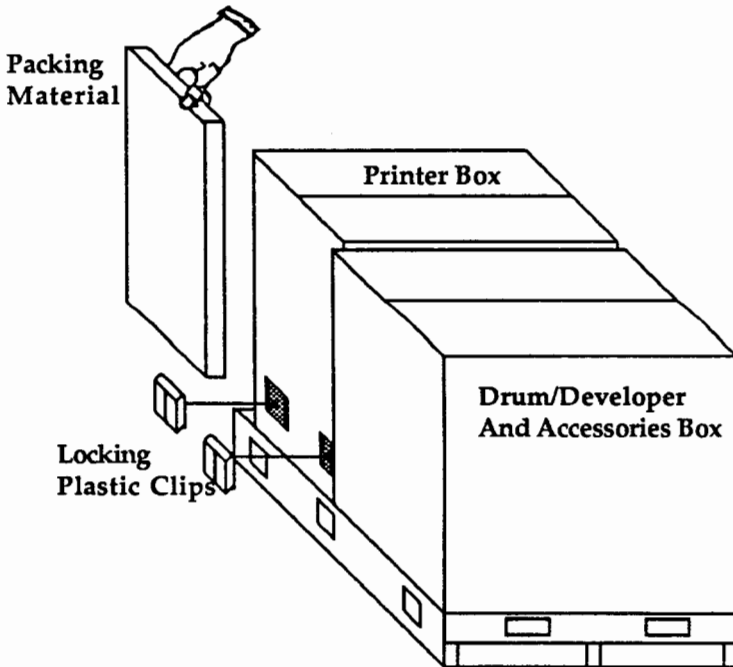

Figure 2.3 Removing Plastic Clips and Packing

8. Lift the printer box top off the printer. The printer is wrapped in plastic.
9. Pull the plastic wrap aside. Cut the tape on the other box and open the flaps.

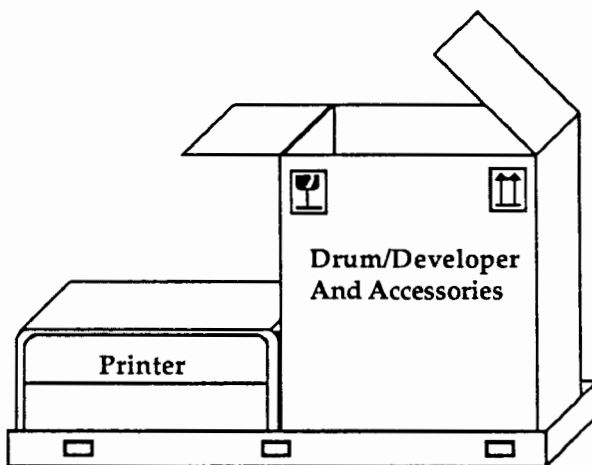

Figure 2.4 Printer and Box

10. Lift the printer away from the platform and set it on the surface where you intend to use it. Check the printer for damage or scratches. Verify the model numbers, production date, and serial number on the manufacturer's name plate to be certain that you have received the right product.
11. Open the boxes containing the face down stacker, drum, developer, and other accessories, and remove them from their boxes.
12. Verify that all the components are included. See the checklist on the following page.



## 2.3 Checklist for Components

Once you have unpacked your Laser Printer, verify that you have all the components. You should have the following items:

- Printer Module
- Photoconductor drum
- Developer unit
- Letter size paper cassette tray
- Output tray
- Face down stacker
- Output tray for stacker
- Power cable
- User manual
- Blow brush



## **Three Installation**

<b>3.1</b>	<b>Installing the Printer Components</b>	<b>3-1</b>
	Installing the Photoconductor Drum	3-2
	Installing the Developer Unit	3-6
	Installing the Paper Cassette	3-10
	Installing the Face Down Stacker	3-12
	Installing the Cables	3-13
	Installing the Output Paper Tray	3-15
<b>3.2</b>	<b>Installing the Font and Emulation Cards</b>	<b>3-16</b>
<b>3.3</b>	<b>Installing Optional Paper Sources</b>	<b>3-18</b>
	Installing the Second Cassette Module	3-18
	Installing the Large Capacity Hopper	3-19



## 3 INSTALLATION

The installation procedures for your Laser Printer are detailed in this chapter. The procedures are step-by-step instructions for installing the printer components including loading your paper cassette with paper.

### 3.1 Installing Your Printer Components

Once you have unpacked the Laser Printer, installation of the hardware components follows. Installation procedures are discussed for the following components:

- Photoconductor drum
- Developer unit
- Paper cassette
- Face down stacker/jogger unit
- RS232C or Centronics interface cable
- Power cable
- Output tray
- IC font cards
- Optional paper sources
  - Second cassette module
  - Large capacity hopper

## Installing the Photoconductor Drum

1. Open the box with the photoconductor drum in it. Remove the packing.
2. Open the front cover of the printer.
3. Lower the carrier station lock lever. Pull out the precharger (charge corona).

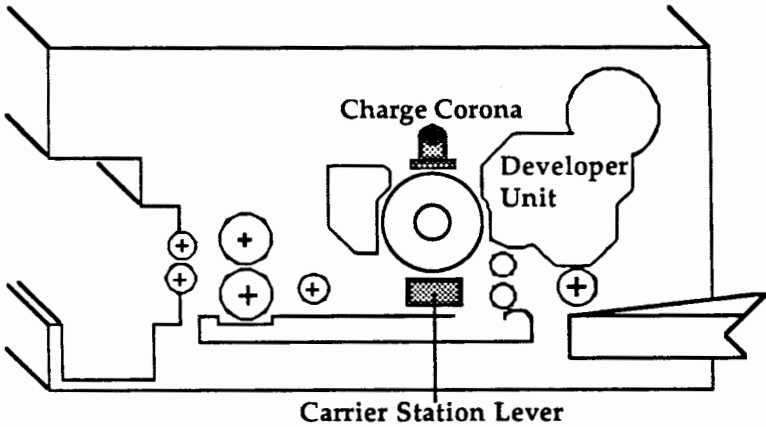

Figure 3.1 Precharger, Drum, and Carrier Station Lever

4. Remove the drum spindle cover by turning the spindle cover counter-clockwise 90° while pushing in on it. Set the cover aside.

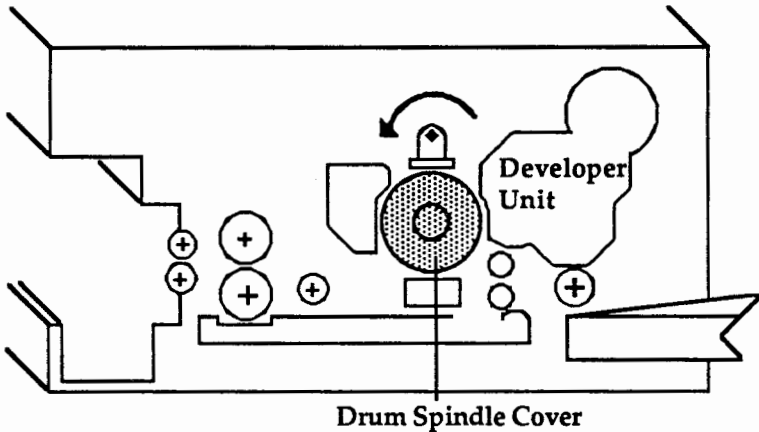

Figure 3.2 Removing the Drum Spindle Cover

5. Remove the gloves enclosed in the box with the drum. Put the gloves on.

**CAUTION**

Do not touch the drum with your bare hands. Oil from your skin can damage the drum.

6. Remove the drum from the box while holding the inside of the drum.

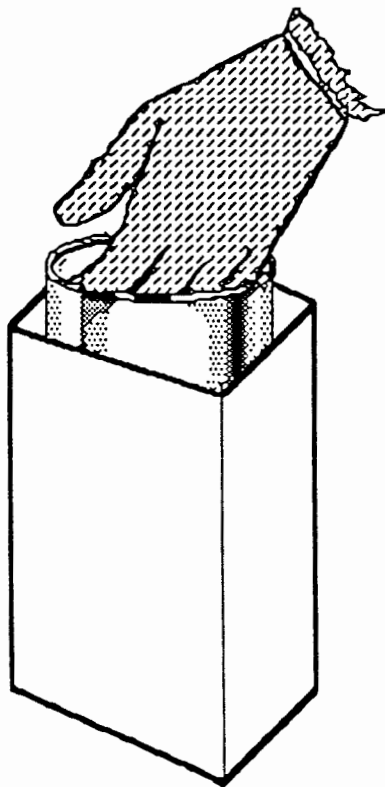
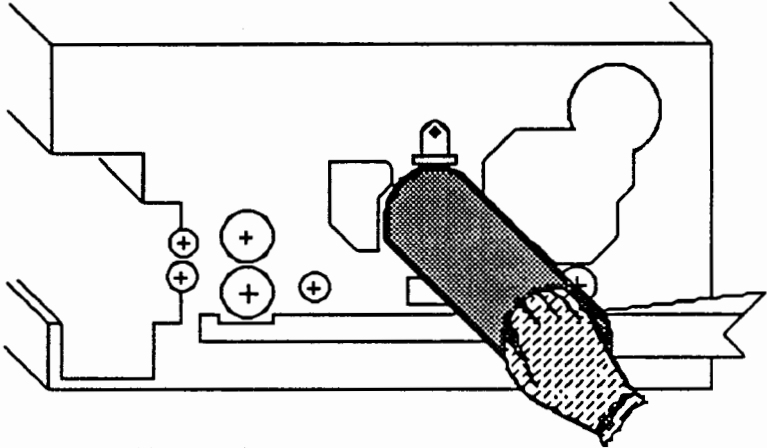

Figure 3.3 Removing the Drum From the Box



7. Hold the drum from the inside and carefully insert the drum along the drum spindle until the drum stops.



**Figure 3.4 Inserting the Drum**

8. Install the drum spindle cover, aligning the two holes with the pins. Turn clockwise 90° to lock the cover in place.
9. Lift the carrier unit.
10. Push the precharger back in to install it.
11. Remove gloves.

## Installing the Developer Unit

1. Open the front cover and the right side cover of the printer.
2. Remove the paper-sealed cover from the developer unit. The developer unit cross-section is illustrated below.

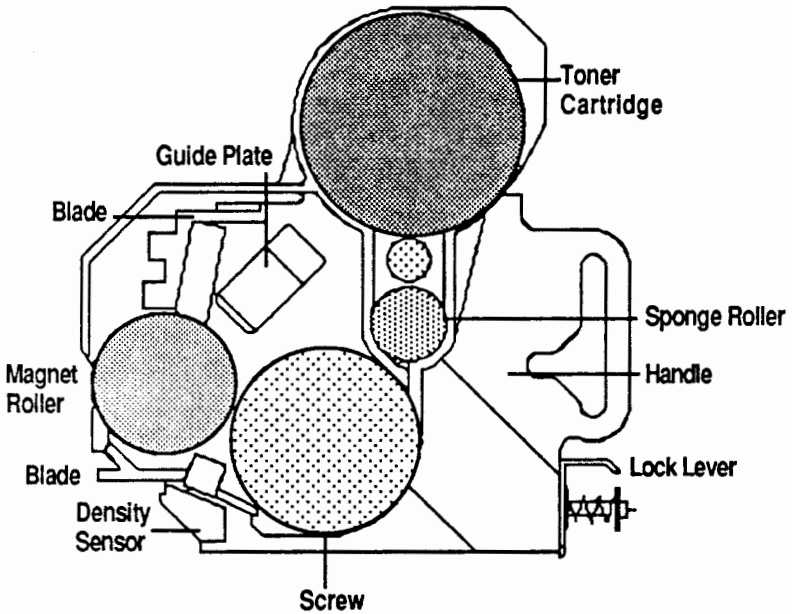
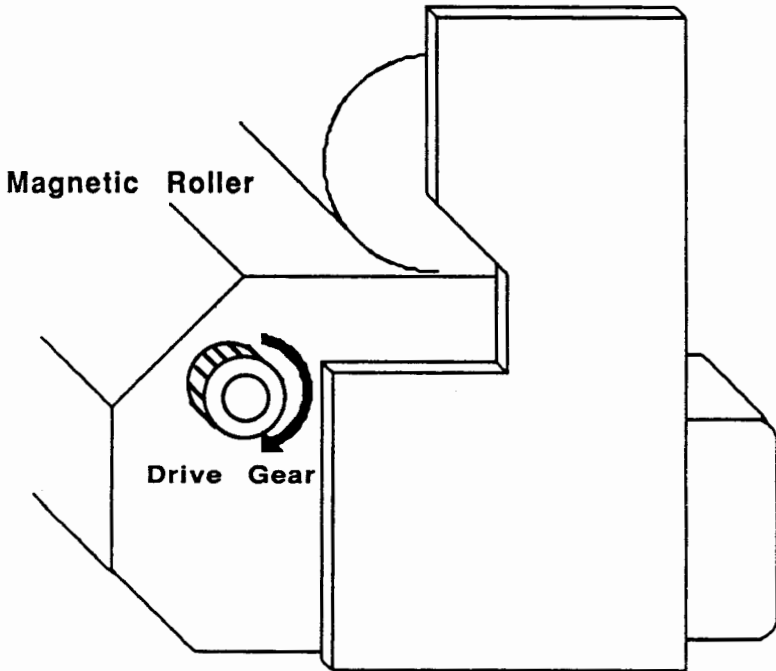

Figure 3.5 Developer Unit Cross-section

3. Turn the drive gear on the magnetic roller of the developer unit clockwise.



**Figure 3.6 Magnetic Roller Drive Gear**

4. Grip the handle of the developer unit with both hands and insert the unit into the printer. Push in firmly to set the unit in place. If the unit does not slide completely in, remove it, and repeat step 3.

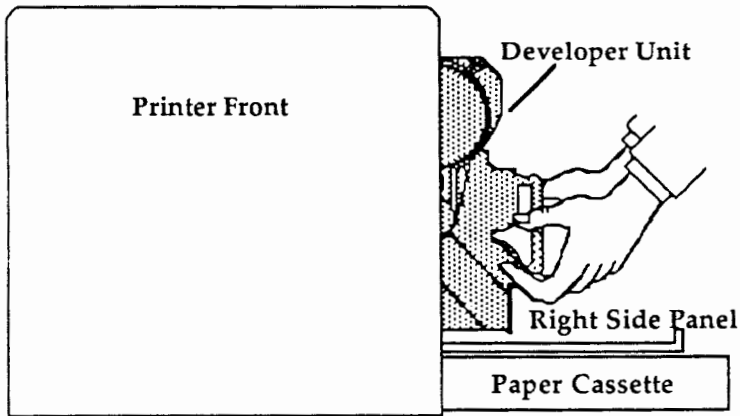
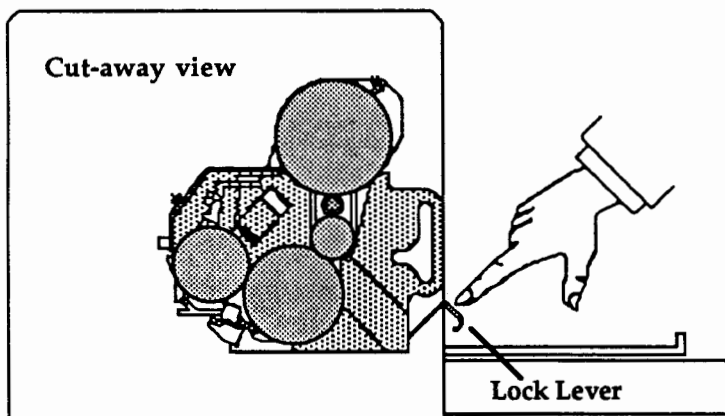

Figure 3.7 Inserting the Developer Unit

5. Lower the lock lever to the lock position. If the lock lever does not lock in place, remove the developer unit and turn the drive gear again so that it meshes with the gear on the inside of the printer.



**Figure 3.8 Pushing the Lock Lever**

6. Close the right cover. If the right cover does not close completely, the developer unit is not completely inserted or the lock lever is not in the full down position.

## Installing the Paper Cassette

1. Remove the cassette from its packing.
2. Take the paper out of the package and bend it towards yourself and then away. This prevents sheets from sticking together.

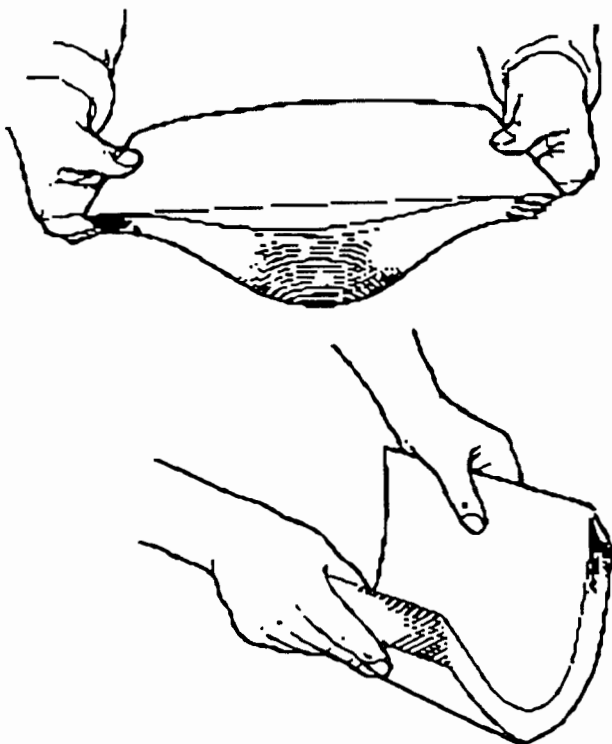

Figure 3.9 Handling the Paper

3. Insert the paper stack into the cassette, back end first. Position the paper under the corner holders at the front end of the cassette.

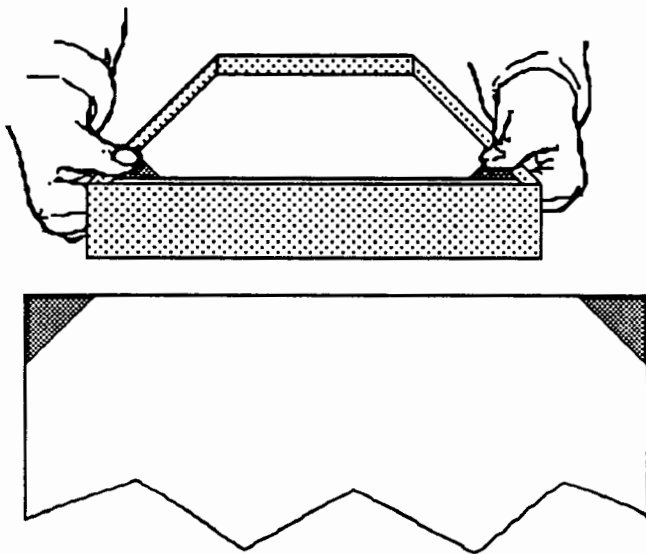

Figure 3.10 Inserting the Paper into the Cassette

4. Rock the cassette gently to settle the paper.
5. Insert the cassette gently into the cassette holder. Do not force it. If the holder does not lock, remove the cassette and try again.

## Installing the Face Down Stacker

1. Remove the face down stacker and its output tray from the packing.
2. Insert the face down stacker into the printer until it locks in place.
3. Insert the pegs on the end of the output tray into the holes in the face down stacker.

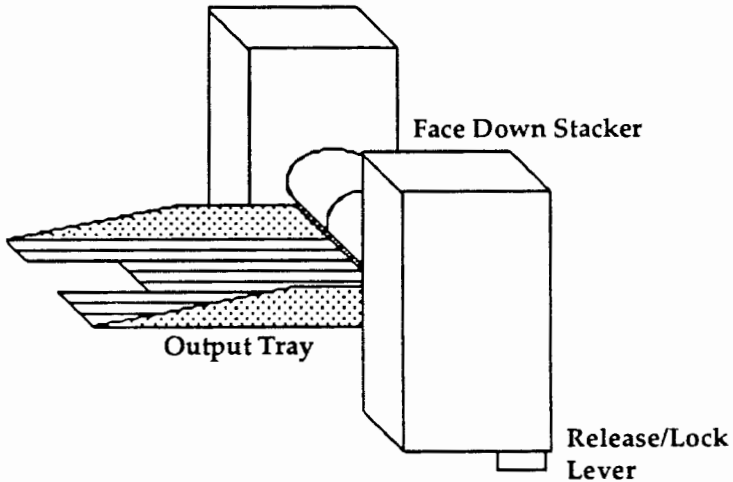

Figure 3.11 Face Down Stacker



## Installing the Cables

1. Insert the RS232C or Centronics cable in the left hand connector.

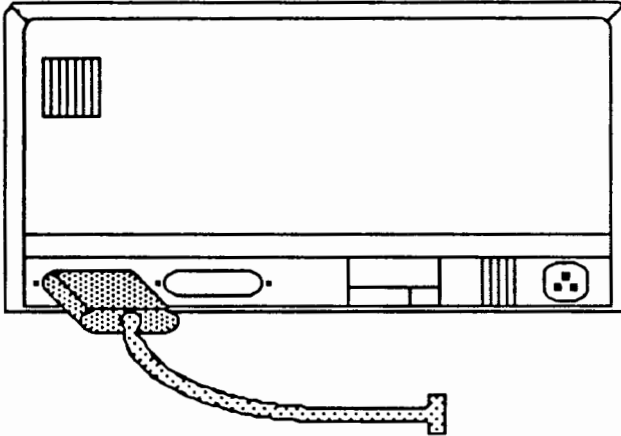

Figure 3.12 RS232C or Centronics Interface Cable

2. Insert the power cable in the power outlet.

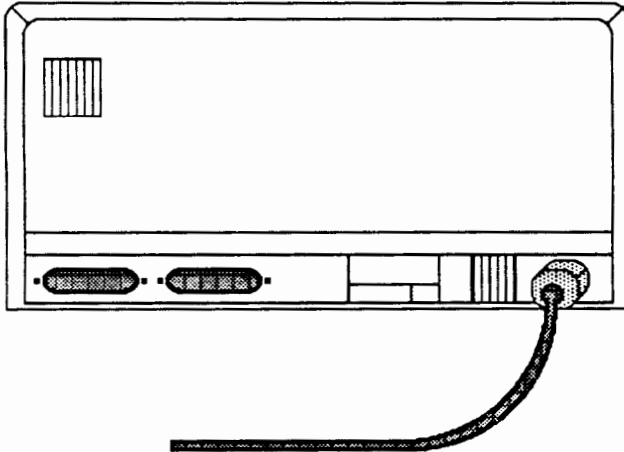
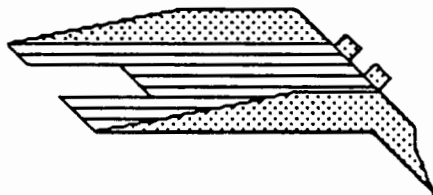

Figure 3.13 Power Cable

## Installing the Output Tray

1. This output tray is only used *without* the face down stacker. If the face down stacker is installed, remove it from the printer.
2. Unpack the output tray from the packing.



3. Insert the output tray in the printer, making sure the pegs of the output tray are inserted in the appropriate holes on the printer.

## 3.2 Installing the Font and Emulation Cards

Integrated Circuit (IC) Cards provide the following capabilities:

- Additional font capability to the fonts currently residing on the printer.
- Capability to change from printer emulations currently residing on the printer to additional and different, emulations.

The following figure shows the correct method of inserting an IC card into one of the three printer slots.

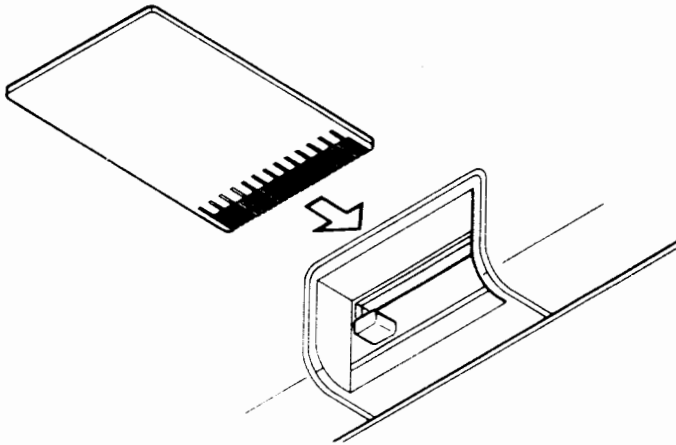

Figure 3.14 IC Card and Card Slot

## What You Do ...

1. Insert the IC Card straight into the card slot until it clicks into place.
2. To remove the IC Card, press the eject button. The card will pop out of the slot.

### NOTE

The Emulation card can only be inserted into the IC Card Slot nearest the Operator Panel. Font cards can be inserted in any of the three card slots.

The names of all IC card emulations and fonts are displayed on the LCD display of the Operator Panel when the VIEW IC CARD key ( Second SETUP Key from the left) is pressed.

### 3.3 Installing Optional Paper Sources

Two additional paper sources are available with the Laser Printer. These optional sources are the:

- Second cassette module
- Large capacity hopper

#### Installing the Second Cassette Module

1. Place the second cassette module on the table where you intend to use the printer.

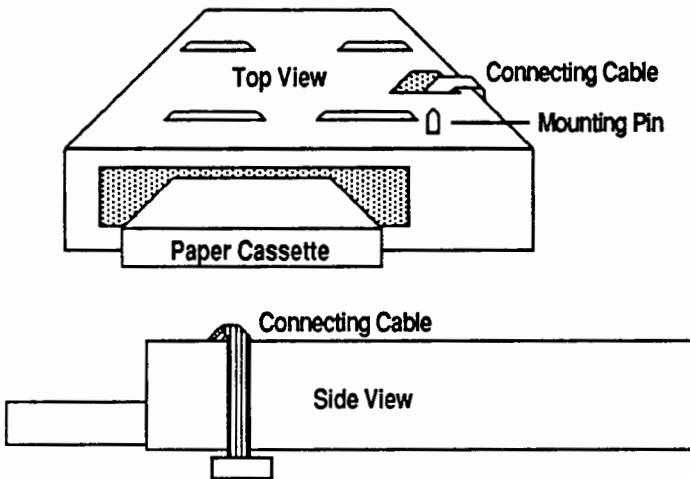

Figure 3.15 Second Cassette Module

2. Place the printer on top of the second cassette module, aligning the mounting pin on the second cassette module with the matching hole on the under side of the printer.
3. Insert the cable attached to the second cassette module into the appropriate port on the printer.

## Installing the Large Capacity Hopper

1. Place the large capacity hopper on the floor.
2. Place the printer on top of the large capacity hopper, aligning the mounting pin on the hopper with the matching hole on the under side of the printer.
3. Insert the cable attached to the large capacity hopper into the appropriate port on the printer.

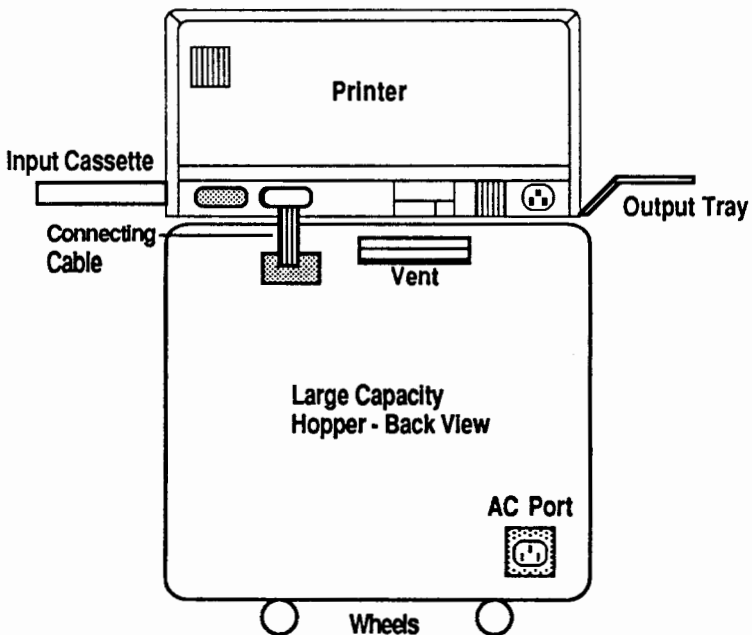

Figure 3.16 Large Capacity Hopper with Printer





<b>Four</b>	<b>Using the Control Panel</b>	
4.1	Overview	4-1
4.2	Quick-Start Tutorial	4-2
4.3	Control Panel Layout	4-5
	Indicator Lights	4-6
	SETUP Keys	4-6
	Error Reset Key	4-7
	Clear/Print Key	4-8
	Arrow Keys	4-9
	SET Key	4-9
	LCD Status/Menu Display Screen	4-10
4.4	Laser Printer Modes	4-11
	Printer Mode	4-11
	Setup Mode	4-12
4.5	Laser Printer Menus	4-13
4.6	Menu Selection and Set	4-17
4.7	MENUS	4-21
	Main Menu Options	4-22
	PRINT	4-22
	MACRO	4-24
	SELFTTEST	4-27
	HEX DUMP	4-28
	EXIT	4-28
4.8	I/F (Interface )Menu	4-30
	RS232 and CENT	4-30
	BAUD	4-31
	FORMAT	4-32
	PROTO (Protocol)	4-34

## **THE LASER PRINTER USER GUIDE**

---

4.9	EMUL (Emulations) Menu	4-36
4.10	PAPER (Device) Menu	4-38
4.11	FONTS Menu	4-40
4.12	PAGE Menu	4-42
4.13	BITMAP Menu	4-46
4.14	IC Font Card Tutorial	4-47

## 4 USING THE CONTROL PANEL

### 4.1 Overview

The Laser Printer Control Panel is described in this chapter. But first, for those who are familiar with the Laser Printer or Laser Printers in general, a Quick-Start Tutorial is provided.

Step-by-step procedures where necessary, are provided on all functions of the Control Panel lights, keys and menus in this chapter. The following are discussed:

- **Control Panel Layout**
  1. Indicator Lights
  2. SETUP Keys
  3. ERROR RESET Key
  4. CLEAR/PRINT Key
  5. Arrow Keys
  6. SET Key
  7. LCD Menu Display
- **Laser Printer Modes**
  1. Printer
  2. Setup
- **Laser Printer Menus**
  1. Main Menu
  2. Interface Menu
  3. Emulations Menu
  4. Paper (Device) Menu
  5. Font Menu
  6. Page Menu
  7. Bitmap Menu
- **Menu Selection and Set**
- **IC Font Card Tutorial**

## 4.2 Quick-Start Tutorial

For those who are familiar with the Laser Printer or Laser Printers in general, this Quick-Start Tutorial is provided.

### What You Do ...

1. Verify that:
  - a. All cables are attached and the Laser Printer is operational.
  - b. Data on your terminal is ready to be sent to the Laser Printer for printing. (Optional)
  - c. The paper cassette (or hopper) is loaded with paper for printing.
2. Turn on the power switch located on the front right-hand side of the Laser Printer.

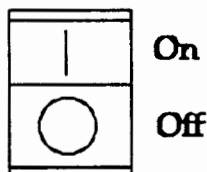

3. Verify that:
  - a. The POWER indicator LED light is ON and showing an amber light.
  - b. The ONLINE indicator LED light is ON and showing a green light.

4. On your status screen you see:

CHECKING SYSTEM

followed by:

WAIT

5. If you have not changed the printer from LASJET<sup>+</sup> emulation you see the following on your Status Screen:

LASJET<sup>+</sup>      PORT

**NOTE:**

**Emulation** means having your Laser Printer act as if it were a specific printer, such as the Hewlett Packard LASER JET PLUS printer. The LASER JET PLUS printer emulation is the System default.

Other emulations resident on your Laser Printer are: D 630 or Diablo 630 printer and the FX80 or Epson FX80 printer.

If you have purchased, and installed on your Laser Printer, an IC EMULATION CARD that emulates another type of printer, the abbreviation for that printer type displays.

6. The Laser Printer is ready to begin printing as if it were a Hewlett Packard LASER JET PLUS printer.
7. To print, type in the print commands from the terminal that sends data to the Laser Printer for printing.
8. When the data has been sent from your terminal, the Laser Printer will start to print.

### 4.3 Control Panel Layout

The Laser Printer Control Panel (Figure 4.1) contains function keys, status indicators, and an LCD Display Screen.

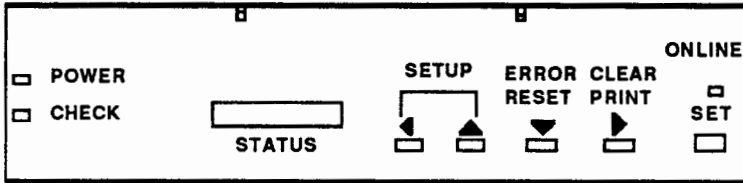

Figure 4.1 Laser Printer Control Panel

1. Indicator Lights
2. SETUP Keys
3. ERROR RESET Key
4. CLEAR/PRINT Key
5. Arrow Keys
6. SET Key
7. LCD Menu Display

Control Panel use depends upon the two operating modes:

**PRINTER MODE**  
**SETUP MODE**

**PRINTER MODE** is the normal, day-to-day printer operation mode. **SETUP MODE** allows you to change the configuration or "setup" of the printer before printing. (See Laser Printer Modes below in this section.)

How you use the keys and menu options depends upon the mode.

## Indicator Lights

The Indicator Lights are as follows:

POWER       CHECK      ONLINE

**POWER**      Amber light is lighted when the printer is on.

**CHECK**      Red light is lighted when the printer has an error condition.

**ONLINE**      Green light is lighted when the printer is online.

## SETUP Keys

The SETUP Keys are dual function keys.

1. The SETUP Keys are used to enter SETUP Mode if they are pressed simultaneously.
2. Once in SETUP Mode, the SETUP Keys become directional Arrow Keys including LEFT Arrow and UP Arrow. The Arrow functions are used to travel through the Laser Printer Menu levels and options.

### SETUP

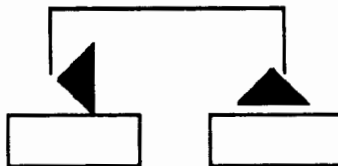



**NOTE**

When in SETUP MODE, and below the Main Menu level, pressing these two SETUP keys simultaneously returns you to the Main Menu level.

**ERROR RESET Key**

The ERROR/RESET Key has triple functions depending upon the mode: Printer or Setup



1. When in PRINTER MODE, press the ERROR RESET key to recheck the printer engine status conditions.
2. If error conditions are found during a rechecking of engine status, the appropriate status codes are displayed on the Display Screen. The key is normally used after an error condition has been cleared by the User and it is only active when the printer is in an idle state.
3. When in SETUP MODE, and an IC CARD has been installed, press this key to reset the VIEW IC FONT CARD function.
4. When in SETUP MODE, and you are moving through the Menus, press this key and it performs as a DOWN ARROW Key.

## **CLEAR/PRINT Key**

The CLEAR PRINT key is a triple function key similar to the ERROR RESET Key. The functions cannot be used except when the Laser Printer is in an idle state.



1. When in **PRINTER MODE**, press the **CLEAR PRINT** key clears the remaining data of the current file being printed.
2. When in **SETUP MODE**, and an **IC FONT CARD** has been installed, press this key to view the names of **IC FONT CARD** fonts as shown on the Screen display.
3. Press the Key again to show the next **IC Font Card** name. When viewing is completed, press the **ERROR RESET** Key again to return to **PRINTER MODE**.
4. When in **SETUP MODE**, and you are moving to the right on each Menu level, press this key and it performs as a **RIGHT ARROW** Key.

### **Arrow Keys**

Notice the arrow keys under the **SETUP**, **ERROR RESET** and **CLEAR PRINT** titles.

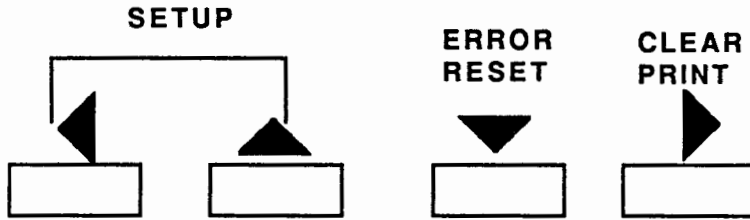

The Arrow keys represent the direction you will travel when moving through the menus:

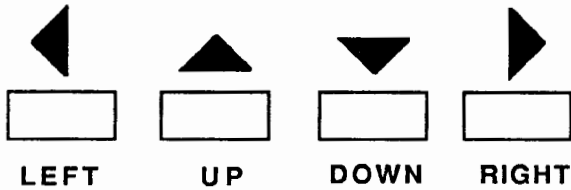

### **SET Key**

In **SETUP MODE**, the **SET** Key performs a Set/Select function. When travelling through the Menus, pressing this Key selects/sets the menu option you see currently displayed on your Screen.

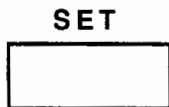

After you have set your menu selection, you are moved to the next menu level and that menu's first option displays for your selection.

## LCD Status/Menu Display Screen

The Control Panel Status Display Screen provides you visual access to the MAIN and SETUP Menus providing up to 16 LCD characters.



**STATUS**

**NOTE:**

To permanently save a change made in the Setup mode,

1. Press the SET key, and exit the SETUP Menu.
2. Reenter the SETUP Menu.

This verifies that the change is permanent.

## 4.4 Laser Printer Modes

There are two Laser Printer Modes:

PRINTER MODE

SETUP MODE

The Status/Menu Display Screen shows you the status of the printer in PRINTER MODE, and it also shows you the Laser Printer Menus and options for you to select and set in SETUP MODE.

### Printer Mode

Normally, once the Printer environment is set, your Laser Printer is easy to operate, requiring only paper re-load as necessary. (See Chapter 7, Maintenance.) You are usually in PRINTER MODE.

To print in PRINTER MODE, all you must do is

- 1 Prepare your data.
- 2 Verify that the Laser Printer has power, is online, and has paper. There may be a short "warm-up" time, and the test print light (located on the side panel of the printer), must stop flashing before you can print.
- 3 Type commands from your terminal telling the Laser Printer to print your data.

## Setup Mode

There are times when you must change the printer parameters, such as installing an IC Font Card or changing the paper size.

To do this, you must enter **SETUP MODE**, make your selections from displayed menu options, set the selections, and then return from **SETUP** to **PRINTER MODE**.

**SETUP MODE** requires you to travel through menus and sub-menus, each containing options for your selection.

There are two methods to initiate the Setup Mode:

### Method 1

1. Press the **SET Key** to take the Laser Printer offline. The green **ONLINE** indicator goes out.
2. Press the two **Setup Keys** to begin Laser Printer setup changes required of your document. (The **ONLINE** indicator LED light is **OFF** and the green light is out. ) You are now in **SETUP MODE**.
3. The word **MENUS** displays on the Status Display screen. You can select and set from the menu options available to you. (See Laser Printer Menus below in this section)

### Method 2

1. The printer is online and is idle.
2. Press the two **Setup Keys**. You are now in **SETUP MODE**.
3. The word **MENUS** displays on the Status Display screen. You can select and set from the menu options available to you.

## 4.5 Laser Printer Menus

Your Laser Printer allows you great flexibility in setting printing requirements according to your needs by providing a series of menu and submenu options for your selection.

The Laser Printer Setup Menu (Figure 4-2) contains seven major levels:

1. Main Menu (Menus)
2. Interface Menu
3. Emulations Menu
4. Paper (Device) Menu
5. Font Menu
6. Page Menu
7. Bitmap Menu

To get to any one of these menu levels from Printer Mode, press the SETUP Keys simultaneously. Once you are in Setup Mode, all you must do to (1) reach the menu or submenu and (2) select the options you require is use the LEFT, RIGHT, UP or DOWN arrow keys located on the Control Panel.

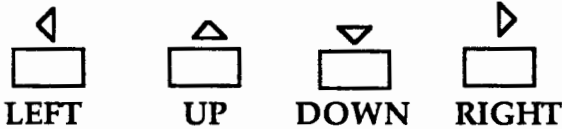

Set the appropriate option under each menu or submenu (using the SET Key) and then use the arrow keys to return to Printer Mode when you are ready to print.

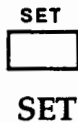







\* FONTS Menu abbreviations are: RM10MIP#8U 0, CR12MUP#8U 0, CR12MIP#8U 0, LP08LUP#8U 0, PE09MUP#8U, PE09MIP#8U, RM10MUP#8U 0

\*\* PAGE menu abbreviations are: TOP MARG, LFT MARG, L SPACE, C SPACE, AUTO CR, AUTO LF, ORIENT, #COPIES

Figure 4.2 Control Panel Menus (PART 2 OF 2)

Each menu level contains several options for you to select. Some of these options are submenus containing other submenu options as shown in Figure 4.2.

As an example of Laser Printer menu options, note one of the seven menu levels (See Figure 4.2), the Main Menu level. This Menu is the first, or top menu level of the Laser Printer menus containing the following menus or menu options for selection:

1. PRINT
2. MACRO
3. SELFTEST
4. HEX DUMP
5. EXIT

**NOTE:**

The Status display screen on the Control Panel shows the menu options one at a time as you press the **right** arrow or **left** arrow to select the appropriate option. (See Menu Selection and Set)

Under the MACRO option is another submenu containing the following five options:

1. DEFAULT
2. M1
3. M2
4. M3
5. M4

For Step-by-step procedures in getting to each menu level, menu or submenu option, and for selecting and setting options, please refer to succeeding sections of this chapter.

## 4.6 Menu Selection and Set

The Control Panel STATUS SCREEN,

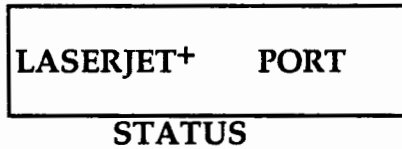

the ARROW KEYS and the SET KEY



are the tools you must use to travel up or down the seven Laser Printer menu levels (from MENU to BITMAP, Figure 4-2), and left or right along each menu level (i.e. MENU, from PRINT to EXIT, Figure 4-2.)

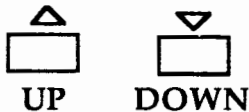

1. The UP and DOWN Keys allow you to move up or down the seven menu levels.

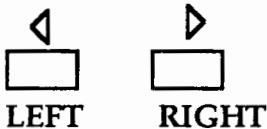

2. Review and select the options of each menu level by using the LEFT or RIGHT Keys.

**SET****SET**

3. To set a menu option, press the SET Key. This action changes the current option setting to the new selection. Each time you select an option in a menu, the first option in the next menu level displays.

BLANK options are found on all beginning menu levels. For example, the Status Screen displays the MENUS or Main Menu as follows:

  
**MENUS**

Press the RiGHT Arrow Key.  
The Status Screen displays:

  
**MENUS****PRINT**

Repeatedly press the RIGHT Arrow Key and the Status Screen displays the following options of the Main Menu:

MENUS	MACRO
-------	-------

MENUS	SELFTEST
-------	----------

MENUS	HEX DUMP
-------	----------

MENUS	EXIT
-------	------

MENUS	
-------	--

Notice that you have returned to the beginning option. In this way you can see that your menus are displayed one at a time in a loop, so that if you mistakenly miss the option you wish to select, you can repeatedly press the RIGHT Arrow Key to return to the option of your choice.



You can also press the LEFT Key to get to an option on a menu level. The menu level options are displayed repeatedly as long as you press the RIGHT or LEFT Arrow Key.

From the next option to the right of the beginning display you see:



MENUS                  PRINT

Press the LEFT Arrow Key to return to the beginning.



MENUS

The screen display at the beginning of each menu level, or submenu level, contains the menu name and what is defined as the BLANK OPTION.



MENUS                  (blank)

The BLANK OPTION as shown on the MENUS illustration above, shows nothing in the Status Screen display except the menu name.

**The BLANK OPTION must display to allow you to press the DOWN Arrow Key or the UP Arrow Key to reach the next menu level. In this case, either the I/F Menu level (DOWN Arrow Key)**



I/F

or the BITMAP Menu level (UP Arrow Key).



BITMAP

## 4.7 MENUS (Main Menu)

1. From SETUP MODE, MENUS displays on the Status Screen with the BLANK OPTION.

MENUS

On this menu level, you can get to five menu options with related submenu options:

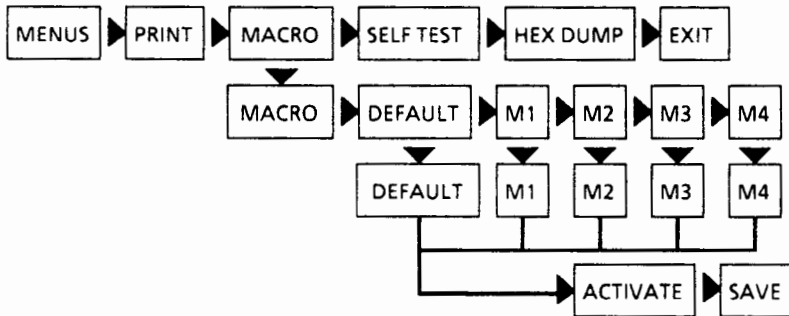

## Main Menu Options

PRINT

Press the RIGHT Arrow Key.



The Status Screen displays:

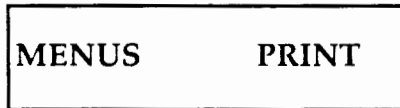

When the PRINT option is selected and set, a one page report on the current system emulation values, including serial communication setup and page format settings is printed out.

The CURRENT ENVIRONMENT SETTINGS Report can be used as a reference on the current Laser Printer system setup. (Figure 4.3)



**CURRENT ENVIRONMENT SETTINGS**

**SERIAL COMMUNICATIONS (IF AVAILABLE)**

BAUD = 9600  
 FORMAT = 8n1  
 PROTOCOL = DTR

CURRENT EMULATION = LASJET+

**PAPER SETTINGS**

FEED = Main  
 ORIENTATION = Portrait  
 TOP MARGIN = 03  
 LEFT MARGIN = 0  
 L SPACING = 06  
 C SPACING = 10  
 AUTO CR = Off  
 AUTO LF = Off  
 NUM COPIES = 01

**FONTS AVAILABLE**

CR12MUP# 8U O  
 CR12MIP# 8U O  
 LP08LUP# 8U O  
 PE09MUP# 8U O  
 PE09MIP# 8U O  
 RM10MUP# 8U O  
 RM10MIP# 8U O

BITMAP TYPE = TEXT

**Figure 4.3 Current Environment Settings Report**

## MACRO

The MACRO submenu level is as follows:

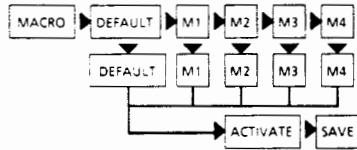

To get to the MACRO menu from the MENUS beginning level, press the RIGHT Arrow Key twice and the Status Screen displays:

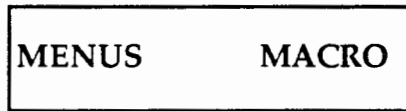

From the MACRO Menu, you have several system emulation (MACRO) options to select or add to the ones your Laser Printer has on the system.

You have the option of storing in the Laser Printer system **up to five different operation environments** that remain on the system even when the power is turned off. The five MACRO options are: **Default, M1, M2, M3, and M4.**

The DEFAULT MACRO (HP LaserJet+) is automatically selected after the Laser Printer power switch is turned on. The other four are determined by the installation of an IC EMULATION Card for each MACRO.

Install the IC EMULATION Card in the slot closest to the front of the Laser Printer. (See Chapter 3, IC Font Card Installation.)

From:

<b>MENUS</b>	<b>MACRO</b>
--------------	--------------

Move to the MACRO submenu by pressing the DOWN Arrow Key.

<b>MACRO</b>	<b>(Blank)</b>
--------------	----------------

View and select from the MACRO submenu by pressing the RIGHT Arrow Key repeatedly.

<b>MACRO</b>	<b>DEFAULT</b>
--------------	----------------

<b>MACRO</b>	<b>M1</b>
--------------	-----------

<b>MACRO</b>	<b>M2</b>
--------------	-----------

<b>MACRO</b>	<b>M3</b>
--------------	-----------

<b>MACRO</b>	<b>M4</b>
--------------	-----------

Select and set the specific MACRO (M1, M2, M3, or M4) that represents the IC EMULATION Card by pressing the DOWN ARROW Key at the appropriate MACRO number. The Status Screen displays:

<b>M4</b>	<b>(Blank)</b>
-----------	----------------

Select the ACTIVATE option by pressing the RIGHT Arrow Key.

<b>M4</b>	<b>ACTIVATE</b>
-----------	-----------------

Press the RIGHT Arrow Key to select the SAVE option.

<b>M4</b>	<b>SAVE</b>
-----------	-------------

Press the SET Key to execute the ACTIVATE option and placing the MACRO (i.e., M4) into the Laser Printer System. The Laser Printer will emulate (act like) the printer option you have selected.

If you do not wish to use the MACRO options, return to the MACRO level by pressing the RIGHT or LEFT Arrow Keys until you reach the MACRO with the blank right side.

<b>M4</b>	<b>(Blank)</b>
-----------	----------------

At that point, press the UP Arrow Key to return to MENUS,

<b>MENUS</b>	<b>(Blank)</b>
--------------	----------------

or the DOWN Arrow Key to go to the next level down, the I/F Menu level.

<b>I/F</b>	<b>(Blank)</b>
------------	----------------

The MACRO you have selected, activated, and saved, is implemented together with all of its associated specifications. The current emulation MACRO is either restarted with the new MACRO values, or a new emulation MACRO becomes the current one.

### **SELFTEST**

From the MENUS level, press the RIGHT Arrow Key repeatedly until the Status Screen displays the next option:

<b>MENUS</b>	<b>SELFTEST</b>
--------------	-----------------

Press the SET Key under the SELFTEST option to enter the Laser Printer into a diagnostic test routine. All elements of the LCD panel light, SELFTEST displays, and all engine status conditions are run. Errors, if any, display.

The Laser Printer continues to print test pages of the COURIER 10 Shift Pattern, until the SET Key is pressed. At this point, the next menu level displays.

**HEXDUMP**

From the **MENUS** level, press the **RIGHT** Arrow Key repeatedly until the Status Screen displays the **HEXDUMP** option:

<b>MENUS</b> <b>HEX DUMP</b>
------------------------------

The **HEXDUMP** option causes the Laser Printer to format all data printed on the Laser Printer from your terminal in hexadecimal for data checking purposes.

The Laser Printer prints the hexadecimal value of each received character, together with its corresponding ASCII character. If ASCII characters of less than 20 (hex) or more than 7F (hex) are received, they are printed as periods (.).

Press the **SET** Key and you will be at the **I/F** (Interface) Menu level. Press the **RIGHT** Arrow Key to get to the next **MENUS** option.

**EXIT**

From the **MENUS** level, press the **RIGHT** Arrow Key repeatedly until the Status Screen displays the next option:

<b>MENUS</b> <b>EXIT</b>
--------------------------

Press the **RIGHT** Arrow Key and the Status Screen returns you to the **MENUS** beginning:

<b>MENUS</b>
--------------

If you wish to return to **PRINTER MODE**, press the **SET Key**.  
The **Online** indicator light is green and the printer is online.

- ▶ If you wish to continue viewing and selecting printer requirement options, press the **DOWN Arrow Key**.  
The **Status Screen** displays:

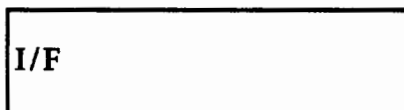

the next menu level down, the **Interface Menu**.

If you have reached the **Interface Menu** level in error, press the **UP Key** at this point to return to **MENUS**, the **Main Menu** level, then press the **SET Key** and return to **PRINTER MODE**.

## 4.8 I/F (Interface) Menu

This menu provides a Serial and a Parallel Interface (I/F) option represented by RS232 (Serial) and CENT (Centronics Parallel) on the INTERFACE Menu level.

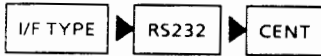

From the MENUS level, press the DOWN Arrow Key to get to the INTERFACE Menu. The Status Screen displays:

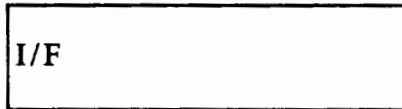

Press the RIGHT Arrow Key to get to the RS232 option.

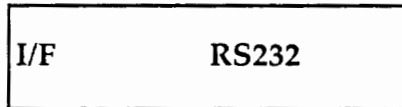

The RS232 (SERIAL) option has a submenu containing the following options of Baud Rate, Format and Protocol.

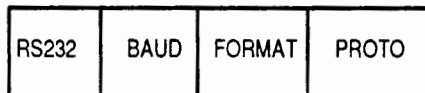



To get to the RS232 submenu press the DOWN Arrow Key.

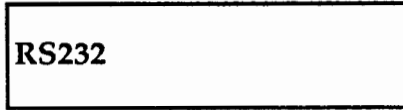

Within the I/F RS232 submenu options are other submenus containing options for your selection and setting:

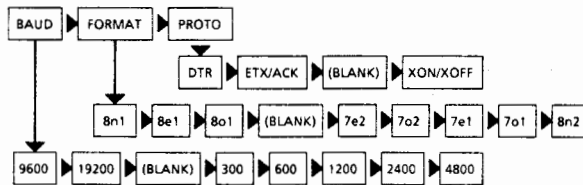

**BAUD**

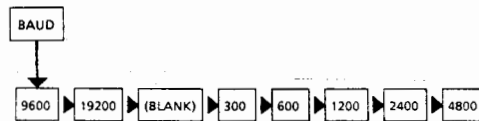

Baud rates are displayed for your selection from 300 to 19200: Options are in menu order: 9600, 19200, 300, 600, 1200, 2400, and 4800.

Select and set the rate as recommended by your communications device manual. When the SET or DOWN Key is pressed, the next Menu level (FORMAT) is displayed.

From the RS232 submenu level, press the RIGHT Arrow Key. The Status Screen displays:

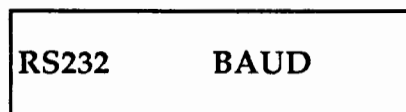

Press the DOWN Arrow Key to get to the BAUD options:

BAUD	9600
------	------

To View all BAUD Options, press the RIGHT Arrow Key repeatedly until you reach the BLANK OPTION. Press the DOWN Arrow Key to get to the next menu level, the FORMAT submenu.

To Select a BAUD Option, press the RIGHT Arrow Key repeatedly until you arrive at the appropriate option. Press the SET Key and then you are automatically sent to the next menu level, (FORMAT submenu options).

In either case, if you wish to return to the RS232 submenu level when you reach a BLANK OPTION, press the UP Arrow Key once.

## FORMAT

The FORMAT submenu contains the following options:

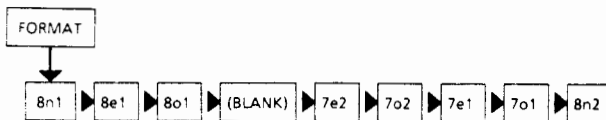

You can enter the FORMAT submenu in one of three ways:

1. From the RS232 submenu press the RIGHT Arrow Key twice, passing the BAUD submenu and going directly to FORMAT.
2. From the BAUD submenu, after you have selected a BAUD option (press the SET Key), you are automatically sent to the FORMAT submenu.

3. Review the BAUD submenu (Press RIGHT Arrow repeatedly until you come to the BLANK OPTION), then press the DOWN Arrow Key

<b>RS232</b>	<b>FORMAT</b>
--------------	---------------

To View all **FORMAT** Options, press the RIGHT Arrow Key repeatedly until you reach the BLANK OPTION. Press the DOWN Arrow Key to get down to the next menu level, the **PROTO(col)** submenu.

To Select a **FORMAT** Option, pthe RIGHT Arrow Key repeatedly to get to the appropriate option: 8n1 through 8n2.

<b>FORMAT</b>	<b>8n1</b>
---------------	------------

Press the SET Key at the appropriate option. The next menu level, (**PROTO** submenu options) displays.

If you wish to return to the RS232 submenu level when you reach a BLANK OPTION, press the UP Arrow Key twice.

*Format for Serial communications.*

Options are:

**8n1, 8e1, 8o1, 7e2, 7o2, 7e1, 7o1, and 8n2**

**e = even**

**o = odd**

**n = none parity type**

Select and set as required by your communications device.

*Number of data bits.*

Bit options are: **7** or **8**. Select and set as required by the length of the data word being transmitted.

*Parity type.*

Options are: **Even**, **Odd** and **None**. Select and set as required by the two communications devices.

*Number of stop bits.*

Options are: **1** or **2**. Select and set as required by how many stop bits are required to follow your data word.

### PROTOCOL (PROTO)

The RS232 PROTOCOL submenu options are:



You can enter the **PROTO** submenu in one of three ways:

1. From the RS232 submenu press the RIGHT Arrow Key three times, passing the BAUD and FORMAT submenus, going directly to PROTO.
2. From the FORMAT submenu, after you have selected a FORMAT option (press the SET Key), you are automatically sent to the PROTO submenu.
3. Review the PROTO submenu (Press RIGHT Arrow repeatedly until you come to the BLANK OPTION), then press the DOWN Arrow Key



Press the DOWN Arrow Key to get to the PROTOCOL options.

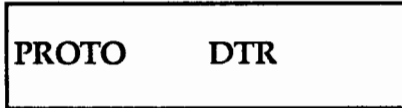

To View all PROTO Options, press the RIGHT Arrow Key repeatedly until you reach the BLANK OPTION. Press the DOWN Arrow Key to get down to the next menu level, the EMUL(ation) menu.

To Select a PROTO Option, pthe RIGHT Arrow Key repeatedly to get to the appropriate option: DTR through XON/XOFF.

Handshake protocols acknowledging transmission sending and receiving are displayed for your selection. Upon recommendations made by your device's manual, select the appropriate protocol option.

Press the SET Key at the appropriate option. The next menu level, (EMUL menu) displays.

The PROTO Menu selections are:

- |                 |  |
|-----------------|--|
| <b>DTR</b>      | Data Transmission Received                         |
| <b>ETX/ACK</b>  | Transmitting/Transmission Completed (Acknowledged) |
| <b>XON/XOFF</b> | Transmitting is On or Off                          |

Press the SET or DOWN Key to get to the next Menu level below the INTERFACE Menu (EMUL). Or, to return to the RS232 level, press the UP Arrow Key three times when you reach the BLANK OPTION.

## 4.9 EMUL (Emulations) Menu

The EMUL Menu options are:

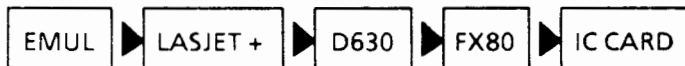

When you have traversed down the SETUP Menu to the EMUL or Emulation menu level, the current (active) emulation mode or name appears in the LCD display.

EMUL LASJET+

### CAUTION

Pressing the SET Key causes an immediate change (RESET) to the current emulation being displayed. Do not press the SET Key unless you require a change to the current emulation. If you press the SET key, all current downloaded fonts and data are lost.

Press the RIGHT Arrow Key repeatedly to get to the appropriate option: D630 through IC\_CARD.

**NOTE:**

**Emulate** is having your Laser Printer act as if it were a specific type of printer, such as the Hewlett Packard LASER JET PLUS printer. The LASER JET PLUS printer emulation is the Laser Printer default.

If you have purchased and installed on your Laser Printer an IC FONT/ EMULATION CARD emulating another type of printer; the abbreviation for that printer type displays on your Status Screen.

The emulations represented on your Laser Printer are: D630 or Diablo 630 printer and the FX80 or Epson FX80 printer.

You have the option of having other printer emulations on the Laser Printer. Just install IC Font/Emulation Cards in the Laser Printer system IC Card Slots.

If you select (press the SET Key), the IC\_CARD option, an emulation that is **not** one of the resident emulations, (**LaserJet+**, **Diablo 630**, and **FX-80**), the Laser Printer searches the IC Card slots for a match.

If there is no match, a message to that effect displays. Either install the required IC Font/Emulation Card, or press the ERROR RESET Key on the Operator Panel. If the ERROR RESET Key is pressed, the Laser Printer default emulation (**LaserJet+**) becomes active.

Press the SET or DOWN Key to get to the next Menu level **below** the EMUL Menu (PAPER). Or, to return to the I/F MENU level, press the UP Arrow Key when you reach the EMUL BLANK OPTION.

## 4.10 PAPER Menu (Device)

From the EMUL(ation) Menu, press the DOWN Arrow Key to get to the PAPER submenu options.



PAPER (Blank)

The PAPER menu options are: MAIN (Cassette), MANUAL (Feed), and 2ND CASS(ette).



Press the RIGHT Arrow Key to get to the next option.



PAPER MAIN

### Main Cassette

The Main Cassette contains up to 250 sheets of paper. This is the default selection.

### Manual (Feed)

If this is selected from the Menu, you can manually feed special types of paper such as letterhead, through the front end feeder slot of the standard paper cassette located on the side of the Laser Printer.



**Second Cassette**

The 2ND CASS (second cassette) option is used to select an additional paper source. The additional paper source can be either the second cassette module or the large capacity hopper. When you select the 2ND CASS option, one of these sources is activated, depending on which source is connected to the printer at the time.

Press the RIGHT Arrow Key repeatedly to get to the appropriate option. Press the SET Key to select the option. That option becomes active and the next menu level (FONTS) is briefly displayed.

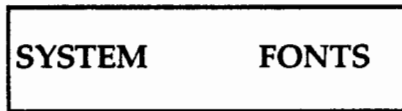

followed by the first font on this Menu.

To return to the EMUL MENU level, press the UP Arrow Key when you reach the PAPER BLANK OPTION.

## 4.11 FONTS Menu (SYSTEM FONTS)

There are seven fonts resident on the Laser Printer System.

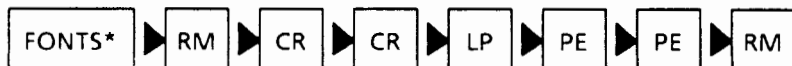

- \* The fonts are abbreviated in this illustration. The fonts are defined on the next page.

From the PAPER Menu, press the DOWN Arrow Key to get to the FONTS submenu options. The following is briefly (3 seconds) displayed.

SYSTEM	FONTS
--------	-------

The first font name quickly displays on the Status Screen.

RM10MIP#8U	0
------------	---

All fonts can be printed in Landscape or Portrait orientation. Only the Line Printer font (LP08LUP#8U 0) does not have italics.

The resident FONTS menu options are:

<b>Menu Selection</b>	<b>Font Name</b>
RM10MIP#8U 0	Times New Roman 10 Italic
CR12MUP#8U 0	Courier 10 Upright
CR12MIP#8U 0	Courier 10 Italic
LP08LUP#8U 0	Line Printer Upright
PE09MUP#8U	Prestige Elite 12 Upright
PE09MIP#8U	Prestige Elite 12 Italic
RM10MUP#8U 0	Times New Roman 10 Upright

On the Status Screen you see each font as you press the RIGHT or LEFT Arrow Keys. For example, the Courier 10 Upright font appears as:

CR12MUP#8U	0
------------	---

**NOTE:**

1. Fonts currently on the system can be viewed via the **Menus PRINT** option.
2. Press the right-hand **SETUP** Key and all currently installed IC Card emulations and fonts are displayed in turn on the Status Display Screen.
3. Press this **SETUP** Key repeatedly to view all emulation and font options. This key can only be used when the laser printer is in idle.

Press the RIGHT Arrow Key repeatedly to get to the appropriate option. Press the SET Key to select the option. That option becomes active and the next menu level (PAGE) is displayed. To go to the next Menu level, press the DOWN Arrow Key at any time.

## 4.12 PAGE Menu

The PAGE menu provides you with paper size, orientation and copy setting options:



From the FONTS menu, press the DOWN Arrow Key to get to the PAGE menu.

**PAGE**            (Blank)

PAGE submenu options are:

<b>TOP MARGIN:</b>	Set top margin, two digits
<b>LFT MARGIN:</b>	Set left margin, two digits
<b>L SPACE:</b>	Set line spacing, two digits
<b>C SPACE:</b>	Set character spacing, two digits
<b>AUTO CR:</b>	Set auto carriage return ON or OFF
<b>AUTO LF:</b>	Set auto line feed ON or OFF
<b>ORIENT:</b>	Set orientation to Portrait or Landscape
<b># COPIES:</b>	Set number of copies, two digits

Press the RIGHT Arrow Key to get to the appropriate PAGE options (i.e., TOP MARG, the first option). If you wish to return to the MENUS level, press the LEFT Arrow once to return to the PAGE and BLANK OPTION, then the UP Arrow Key.

PAGE	TOP MARG
------	----------

Press the SET Key and the TOP MARGIN option displays with two digits to the far right:

TOP MARG	0 0
----------	-----

The first digit to the left represents figures in the tens (from 0 to 90), i.e., 0, 10, 20, 30, etc. To select from this "ten" column, move the UP or DOWN Arrow Keys until you have selected the appropriate top margin width.

Press the SET key, then the DOWN Arrow Key, to get to the second digit column.

TOP MARG	0 0
	(ten) (one)

To select from the next column to the right, or "one" column, select the appropriate number (from 0 to 9), i.e., 0, 1, 2, 3, etc., by pressing the UP or DOWN Arrow Keys. Then press the SET key. The next submenu option, LFT MARG displays:

LFT MARG	0 0
	(ten) (one)

If you want to change back to the "ten" column, press the LEFT arrow key and make your changes as before. Once you have completed your column digit selections and want to set them, press the SET Key.

Repeat the procedure for LFT MARG (Left Margin), L SPACE (Left Space), and C SPACE (Center Space) as outlined above for TOP MARG (Top Margin) until you reach the AUTO CR (Automatic Carriage Return) option.

In this way, you can set your line spacing, for example, to two or three by selecting 02 or 03, your copy numbers to ten or twenty by selecting 10 or 20.

For each PAGE option, with the exceptions of AUTO CR, AUTO LF and ORIENT, pressing the SET Key displays the two digit columns with the menu option.

From C SPACE, press the DOWN Arrow Key to get to AUTO CR.

AUTO CR	OFF
---------	-----

To set the parameters for AUTO CR press the RIGHT Arrow Key until you reach the ON, OFF, and BLANK options. Select the appropriate option.

At the BLANK OPTION, press the DOWN Arrow key to get to the AUTO LF option and repeat the same procedure as for AUTO CR.

Press the DOWN Arrow Key to get to the ORIENT(ation) options.

ORIENT	PORT
--------	------

Press the RIGHT Arrow Key to select either PORT(rait), LAND(scape) or BLANK options. Press the SET Key to execute Portrait or Landscape. For the BLANK option, press the DOWN Arrow Key to get to the # COPIES option.

# COPIES	0 0
----------	-----

For this option, repeat the procedures as for TOP MARG (Top Margin). When the last figure is set by pressing the SET KEY, the next menu level down, BITMAP, displays.

Press the RIGHT Arrow Key to get to the PAGE Menu options.

To return to PAGE while in the top level, press the LEFT or RIGHT Arrow keys.

To return to PAGE from the options (i.e. TOP MARG or AUTO CR), press the LEFT or RIGHT Arrow Keys to get to the top level, then LEFT or RIGHT Arrow Keys to PAGE.

From PAGE, press the UP or DOWN Arrow Keys to return to the MENUS level.

### 4.13 BITMAP Menu

From the PAGE menu, press the DOWN Arrow Key to get to the BITMAP menu .



The selections are: **TEXT** or **GRAPHICS**.

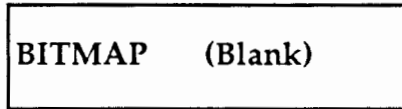

Press the RIGHT Arrow Key to get to the appropriate option.

**TEXT** mode is partial bitmapping and should be sufficient for most purposes including some graphics.



**GRAPHICS** mode is single bitmapping provided for large and complex graphics or text application requirements.



## 4.14 IC FONT Card Tutorial

Install the IC Font Card into the Laser Printer as the procedures outline in Chapter 3, Installation.

### HOW TO DO IT ...

-   Press the LEFT and UP keys (SETUP) simultaneously until the Status Screen displays the following:

MENUS

-  Press the UP Key. Repeat until SYSTEM FONTS is displayed. In a few seconds, the name of the selected font is displayed.

SYSTEM FONTS



3. Press the RIGHT Key. Repeat until the IC\_CARD font you have installed on the Laser Printer is displayed. You will see all seven resident fonts displayed before the IC\_CARD FONT name is reached.

RM10MUP#8U      0

through to

RM10MIP#8U      0

followed by

(Name of IC CARD FONT)

SET



4. Press the SET Key to activate the displayed font. The next menu level displays:



PAGE

5.  Press the DOWN Key. You are on the next menu level down and the following message displays:

BITMAP      TEXT

or

BITMAP      GRAPHICS

6.   Press the LEFT or RIGHT key. Repeat until the following displays:

BITMAP

7.  Press the DOWN Key. You are on the next menu level down and the following displays:

MENUS

8.  Press the LEFT key. Repeat until EXIT displays.

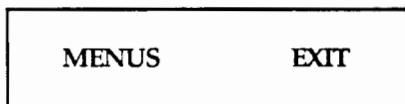

9.  Press the SET Key. The Laser Printer displays the following indicating IC FONT CARD setting is complete and you are in PRINTER MODE.

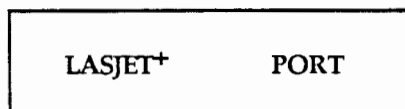

**Five      Printing**

5.1	Overview	5-1
5.2	Preparation and Setup	5-1
	Page Orientation	5-1
	Effective Print Area	5-4
5.3	Printer Emulation and Control Codes	5-5



## 5 PRINTING

### 5.1 Overview

This section discusses printer preparation including effective print area, page orientation and paper setup dimensions. The printer commands for the three resident printer emulations (LaserJet+, Diablo 630 and Epson FX-80) are also provided.

### 5.2 Preparation and Setup

#### Page Orientation

Your printer allows both portrait and landscape page orientation. (Figure 5.1).

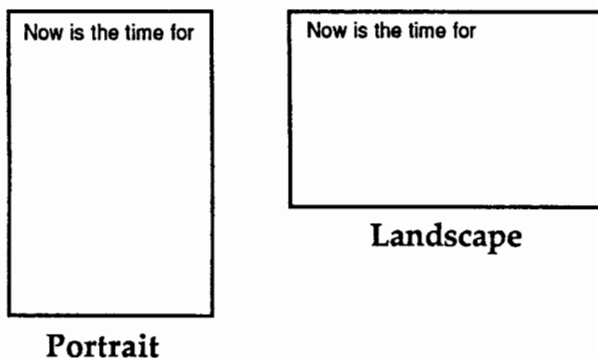

Figure 5.1 Portrait and Landscape Orientation

Page orientation can be changed in three ways:

1. Using the Orientation Selection command in HP LaserJet+ emulation mode.
2. Using the Orientation Selection command of the Extended Command Set in Epson (FX) 80 and Diablo 630 emulation modes.
3. Using the Orientation Selection option in the Operator Panel SETUP menu "PAGE" sub-menu.

Please refer to chapter 4, Control Panel, for detailed instructions on page orientation setup.



## Effective Print Area

Figure 5.2 illustrates the effective print area from your printer.

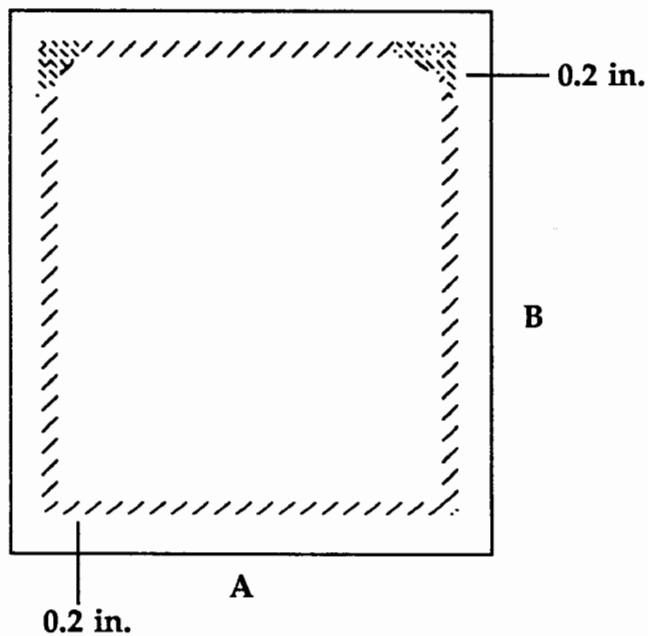

Figure 5.2 Effective Print Area

The printer does not print within 2/10 of an inch on the edge of the page. The remaining effective print area is listed in the following table.

Paper Type	Dimension A	Dimension B
B4 size	9.7 in	13.9 in
A4 size	7.9 in	11.3 in
B5 size	9.7 in	6.8 in
Letter size	8.1 in	10.6 in
Legal size	8.1 in	13.6 in

**Table 5.1 Paper Dimensions**

If a heavier weight paper than normal is used, the print on the right and left top edges of the page may not print as sharply as usual.

### 5.3 PRINTER EMULATIONS AND CONTROL CODES

The printer has three resident printer emulation modes: LaserJet+, Diablo 630 and Epson FX-80. The current emulation mode appears on the display when the unit is online.

LaserJet+ is the default emulation. The emulation mode is selected by pressing the SET key on the Operator Panel while in the EMUL (emulation) sub-menu. If a non-resident emulation is selected, the controller searches the IC card slots for a match. If no matching emulation is found, (No IC emulation card is installed.), LaserJet+ is selected by default.

When a new emulation mode is selected, the printer emulation default settings are initialized.

If the SET Key is pressed when the active emulation is being used, all downloaded fonts and data are lost.

The Control Codes for the three resident emulation modes are provided in Appendix D of this Guide.



**Six      Fonts**



## 6 FONTS

Seven fonts are resident with your printer. Font usage can make your document look more readable, capturing the reader's attention, communicating your message with clarity and taste. While not wholly representative of the commercial typographer's art, you will find that the fonts on your printer will go a long way toward making your printed documents look professional.

The seven resident Font options, as shown on the display screen Menu are:

<b>Menu Selection</b>	<b>Font Name</b>
CR12MUP#8U 0	Courier 10 Upright
CR12MIP#8U 0	Courier 10 Italic
LP08LUP#8U 0	Line Printer Upright
PE09MUP#8U	Prestige Elite 12 Upright
PE09MIP#8U	Prestige Elite 12 Italic
RM10MUP#8U 0	Times New Roman 10 Upright
RM10MIP#8U 0	Times New Roman 10 Italic

To change your fonts, enter SETUP Mode and move the DOWN directional arrow to SYSTEM FONTS. View the font options by pressing the RIGHT or LEFT Arrow Keys. Select/Set a font. If the font change does not occur, check your operating or applications software documentation.

In addition, the printer has the capability for a variety of additional fonts, as well as signatures and logos. This capability is supported through the use of IC (Integrated Circuit) Font Cards that you install on the printer in any one of three available card slots.

To install, insert the card into the slot, (much like a disk into a disk drive). When you wish to change the card, press the slot button, and the card pops out (or ejects), from the slot. Detailed procedures for IC Card installation are found in Chapter 3, Installation.



## **Seven Maintenance**

<b>7.1</b>	<b>General Printer Maintenance</b>	<b>7-1</b>
	<b>Charger</b>	<b>7-1</b>
	<b>Front Cover</b>	<b>7-2</b>
	<b>Carrier Station</b>	<b>7-2</b>
	<b>General Maintenance Schedule</b>	<b>7-3</b>
<b>7.2</b>	<b>Replacing the Toner Cartridge</b>	<b>7-4</b>
<b>7.3</b>	<b>Storage and Treatment of Paper</b>	<b>7-9</b>
<b>7.4</b>	<b>Replacing the Photoconductor Drum</b>	<b>7-10</b>



## 7 MAINTENANCE

### 7.1 General Printer Maintenance

This chapter provides general procedures for the maintenance of your printer including cleaning of the charger, front cover, and carrier station. The procedures also include a General Maintenance Schedule. In addition to General Maintenance, procedures for the replacement of the toner cartridge and the photoconductor drum are also provided.

#### CAUTION

Verify that the power supply to the printer has been disconnected before you perform any maintenance operations.

#### Charger

Clean the charge corona wire every time the toner cartridge is replaced.

#### What You Do ...

1. Open the front cover and pull out the charge corona. The charge corona handle is the green handle above the photoconductor drum.
2. Remove any toner or dust using a blower brush.

## Front Cover

### What You Do ...

1. Open the front cover.
2. Remove any toner dust adhering to the inside with a damp cloth or blower brush.

## Carrier Station

### What You Do ...

1. Lower the carrier station. The carrier station handle is the green handle below the photoconductor drum.
2. Dampen a soft, clean cloth and gently wipe the carrier station.
3. Remove the carrier corona and clean it with the blower brush.

---

**GENERAL MAINTENANCE SCHEDULE**

<b>Sheets</b>	<b>Approximate Time</b>	<b>Maintenance</b>
1250	1 Day	Add paper
6000	1 Week	Replace toner cartridge. Replace collector bottle. Replace oil felt. Clean corona wires. Dust off toner particles.
65,000	2 to 3 months	Replace print station kit. Clean toner and paper dust.

**NOTE:**

The toner collector bottle should be replaced when the toner cartridge is replaced. This allows the Reset switch to be reset properly near the collector bottle.

## 7.2 Replacing the Toner Cartridge

One toner cartridge should last for approximately 6000 sheets of letter size paper. If the printing quality becomes increasingly faint, it is probably because the toner cartridge should be replaced. The LCD will also display ADD TONER.

### What You Do ...

To replace the cartridge, follow these procedures:

1. Open the front cover. Move the cartridge slightly in both directions to remove any toner sticking to it. Turn the cartridge 180° counter-clockwise and then remove it gently.

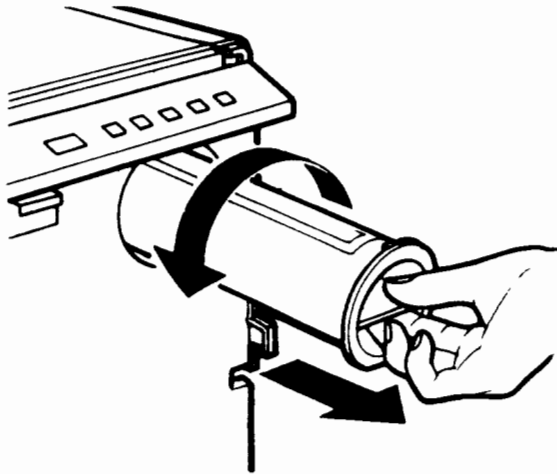
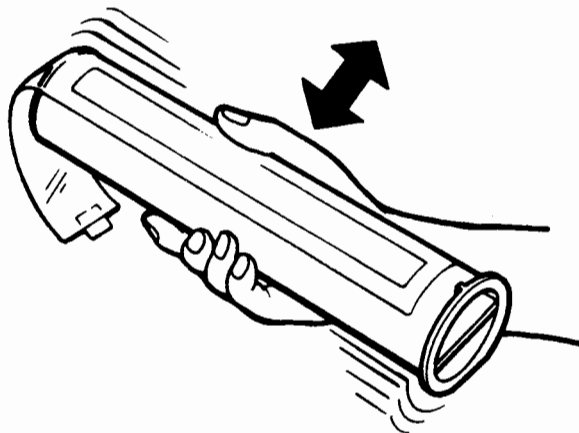

Figure 7.1 Removing the Toner Cartridge

2. Shake the new toner cartridge gently to distribute the toner evenly.



**Figure 7.2 Shaking the Toner Cartridge**

3. Insert the new cartridge while removing the seal. Do not turn it until insertion is complete. When it is fully inserted, turn the cartridge 180° clockwise.

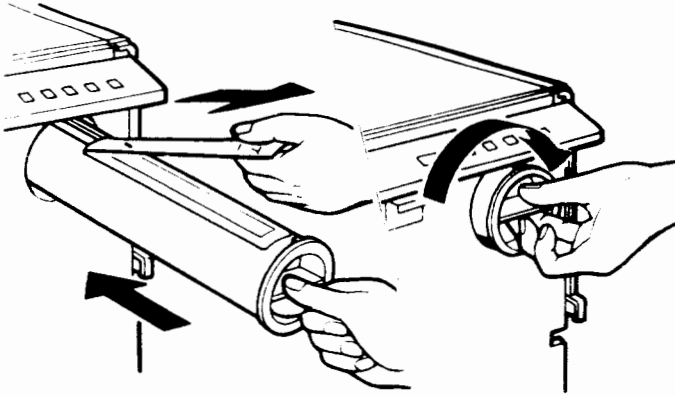
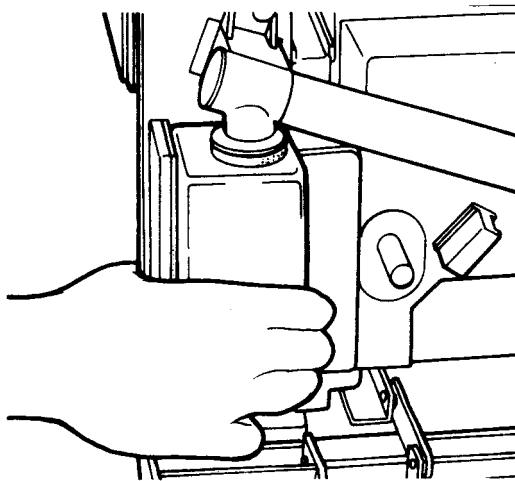

Figure 7.3 Removing the Plastic Seal



4. Confirm that the cartridge is locked by pulling it gently.
5. Tap the duct at the neck of the toner collector bottle to drop loose toner into the collector bottle.
6. Remove the toner collector bottle and seal it. Replace it with a new toner collector bottle.



**Figure 7.4 Replacing the Toner Collector Bottle**

7. Replace the oil felt (green handle).

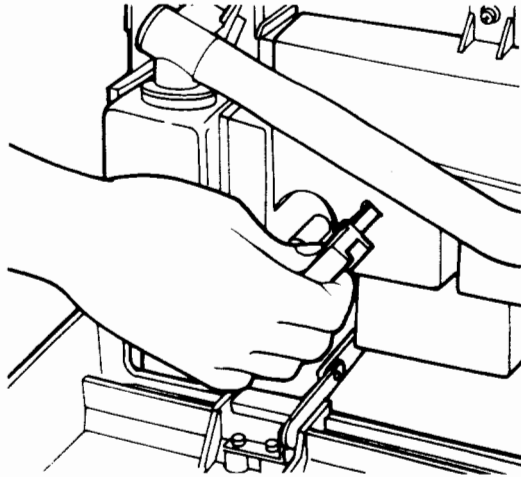

**Figure 7.5 Replacing the Oil Felt**

- 8 When the toner collector bottle and oil felt have been replaced, close the front cover.

### **7.3 Storage and Treatment of Paper**

To avoid paper jams and other problems, your printer paper must be properly stored and maintained.

1. Paper should never be exposed to moisture. Store it in a dry place, away from direct sunlight. Keep unwrapped paper in polyethylene.
2. If the paper gets too dry, it is likely to cause an electrostatic charge. Again, keep it wrapped to avoid this.
3. Do not store paper in an upright position.
4. Paper should never be exposed to rapid variations in temperature and humidity. Paper exposed to such conditions may develop undulations. Paper in this condition will probably cause a printer jam. If your chosen storage area undergoes such a variation, in relation to the printer operation area, leave the paper packed in its wrapping for as long as you can.

## 7.4 Replacing the Photoconductor Drum

As mentioned in the Installation section, retain the original packing materials in a secure storage area. When the printer drum requires replacement, you will need the packing to return the drum to your vendor.

### NOTE

Your photoconductor drum must be returned to your vendor. Do not discard the drum in any other manner.

Review the installation procedures in Section 3, Installation, and reverse the procedure steps.

### What You Do ...

1. Remove the charge corona.
2. Lower the carrier.
3. Remove the developer unit.
4. Remove the photoconductor drum lid assembly.

### CAUTION

Remember to use the gloves that came with the photoconductor drum when handling the drum.

5. Remove the photoconductor drum from the printer while holding the inside of the drum. **DO NOT TOUCH THE SURFACE OF THE DRUM.**
6. Install new photoconductor drum by reversing the order of removal.



**Eight Problems and Solutions**

8.1	Overview	8-1
8.2	Paper Jamming Problems	8-2
8.3	Clearing Paper Jams	8-3
8.4	Print Quality Degradation	8-4
8.5	Laser Printer Error Messages and Conditions	8-5





## 8 PROBLEMS AND SOLUTIONS

### 8.1 Overview

While your printer is relatively trouble free, occasional paper processing and print quality problems can occur. This chapter discusses two major problems, with possible reasons and solutions:

- Paper Jams
- Print Quality Degradation

This chapter also provides an Error Messages and Conditions Table for your reference.

Figure 8.1 shows how paper is carried internally through the printer.

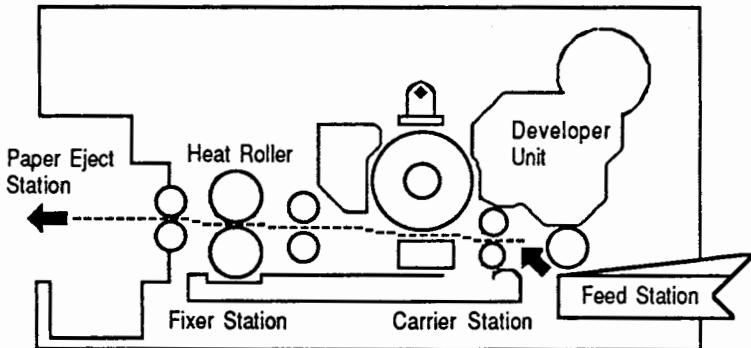

Figure 8.1 Paper Route

## 8.2 Paper Jamming Problems

The following chart indicates the usual problems that occur when the paper is jammed in either the hopper or the manual cassette tray.

Reason	Solution
The paper is folded, creased or torn.	Remove the damaged paper.
The paper cassette is not properly set.	Remove the cassette gently and reset it.
There is too much paper in the cassette.	The cassette should ideally be three-quarters full. Remove the excess paper.
The paper is not set under the corner holders.	Remove the cassette and reset the paper under the corner holders.
The printer is set for manual feed.	Release the manual feed lock.

## **8.3 Clearing Paper Jams**

- 1. If jammed paper is left in the printer for a long time.**

Mechanical problems may result. Remove jammed paper as soon as possible.

**CAUTION:**

The heat roller retains a high temperature for some time. To avoid possible burns, do not touch the roller when you remove the paper.

- 2. If paper jams occur in the paper eject station:**

Open the front cover, lower the carrier station using the lock lever (green handle) and remove the jammed paper while pushing the paper eject station lock lever upward.

- 3. If paper jams occur in the carrier station or fixer station:**

Lower the carrier station and remove the jammed paper.

#### 4. If paper jams occur in the paper feed station:

Pull out the paper cassette. Then open the front cover, lower the carrier station lock lever and remove the paper gently, being careful not to tear it.

Then re-insert the paper cassette, reset the carrier station lock lever and close the front cover.

## 8.4 Print Quality Degradation

The following chart indicates the usual problems that occur when the print quality has degraded and is lower than normal standards.

Symptom	Solution
Printed sheets have streaks.	Paper storage is inadequate. The paper has been left in a high-humidity environment. Replace the paper.
Paper quality is too faint, page is dirty	The Charger wire may need cleaning.
Print density is inadequate.	Adjust the density switch. Print at least 15 pages to verify the print density.

## 8.5 Laser Printer Error Messages and Conditions

This MESSAGE DESCRIPTION AND ANALYSIS section provides a brief overview of the most common error messages and the possible error conditions that cause them. It is not intended as a troubleshooting guide.

Error Message	Description	Analysis
NO DISPLAY	There is no message on the LCD display of the operator panel.	This indicates that either the operator panel interface or the processor subsystem is not working.
RAM ERROR	RAM ERROR is displayed on the operator panel.	This indicates that the processor has discovered a RAM problem during self-testing. It is usually a problem in the timing or refresh of the dynamic RAM.

Error Message	Description	Analysis
<b>CONTROLLER ERROR</b>	CONTROLLER ERROR is displayed on the operator control panel	This is usually a general error. It indicates that the processor has jumped out of its normal program flow. If the error occurs during printing, the problem may be in the DMA circuitry. If it occurs randomly, it may be located in the RAM refresh area. Turn the system off and restart.
<b>CHECKING SYSTEM</b>	CHECKING SYSTEM is displayed continuously on operator panel display.	This problem can occur if the processor freezes operations during the power-up testing. Turn the system off and restart.
<b>I/F ERROR</b>	I/F is displayed on the LCD display of the operator control panel.	This indicates that an error has been detected in the interface between the engine and the controller. This is usually a parity error. Check Printer selection

<b>Error Message</b>	<b>Description</b>	<b>Analysis</b>
TIMER ERROR	TIMER #0 ERROR TIMER #1 ERROR or TIMER #2 ERROR is displayed on the operator panel.	The problem may be in the timer chip, the timer chip interface to the data bus or the per- pheral interface.
Printer prints all white or all black pages.	The printer runs, but all pages printed are all white or black.	If the data feeding the printer is correct, then the source of the problem printed is probably the DMA subsystem and the serialization of the retrieved data.
Random and garbled printing pages.	This is characterized by random writing to the printed page. This is usually seen as random horizontal bars on the page.	This usually indicates an addressing problem of the DMA subsystem.
Display reads PRINTING but the printer does not print.	This is characterized by a continuous display of PRINTING on the LCD display while the engine goes through various operational states.	The controller may be malfunctioning and unable to detect the next printer state.

Error Message	Description	Analysis
<b>NO RS232</b>	This problem is characterized by the inability of RS232 devices to communicate with the printer.	This indicates there is an ACIA chip malfunction, its interface, or the RS232 drivers. Differences in baud rate or protocol can also cause this problem.
<b>Centronics Interface does not work.</b>	This problem is characterized by the inability of Centronics-compatible devices to communicate with the printer.	This indicates a failure in the Centronics data input port or its associated control circuits.



## **Appendices**

<b>A</b>	<b>Physical Specifications</b>	<b>A-1</b>
<b>B</b>	<b>Functional Specifications</b>	<b>B-1</b>
<b>C</b>	<b>Supplies and Accessories</b>	<b>C-1</b>
<b>D</b>	<b>Printer Emulation Control Codes</b>	<b>D-1</b>
	<b>LaserJet+ Control Codes</b>	<b>D-2</b>
	<b>Diablo 630 Control Codes</b>	<b>D-8</b>
	<b>Epson FX-80 Control Codes</b>	<b>D-14</b>
	<b>Extended Commands</b>	<b>D-22</b>
	<b>Raster Graphics (HP)</b>	<b>D-34</b>
<b>E</b>	<b>Status and Error Messages</b>	<b>E-1</b>
<b>F</b>	<b>Printer Options</b>	<b>F-1</b>
<b>G</b>	<b>Serial and Parallel Pinouts</b>	<b>G-1</b>



# Physical Specifications

✓ 1. Power requirements

Voltage	120
Frequency	50/60 Hz
Phase	Single

2. Dimension without paper cassette & stacker

Width	19.1 in.
Depth	20.1 in.
Height	12.2 in.

3. Weight 95 lb.

4. Ambient temperature

✓

Operating	50° F to 95° F (10° C to 35° C)
Non-operating	32° F to 95° F (0° C to 35° C)

5. Relative Humidity

20% to 80%

6. Maximum wet bulb temperature

84.2° F (29° C)

7. Acoustic noise

Less than 55 DBA

✓ 8. Power consumption

Less than 1 KVA



# Functional Specifications

1. Technology Laser diode and electrophotography
2. Developing Method Two component magnet brush development
3. Fixing Heat roller fixing
4. Mechanical Control Interface Video interface
5. Print Speed
  - Letter 18 sheets/min
  - Legal 14 sheets/min
  - A4 17 sheets/min
  - B4 14 sheets/min
6. Resolution 300 x 300 dpi
7. Warming Up Time 110 second maximum
8. First Print 20 second maximum (A4)
9. Paper Size
  - A4 10.1 in. x 14.3 in.
  - B4 8.3 in. x 11.7 in.
  - B5 7.2 in. x 10.1 in.
  - Letter 8.5 in. x 11 in.
  - Legal 8.5 in. x 14 in.
10. Paper Weight 17 to 24 lb

- 11. Postcard  
    Thickness            39 lb
- 12. Cassette capacity 250 sheets
- 13. Stacker capacity  About 250 sheets

## **Supplies and Accessories**

<b>Item</b>	<b>Part Number</b>	<b>Description</b>
Print Station Kit	FS55000004-01	A replacement kit which includes the drum, drum cleaner station, charge corona, transfer unit, and the toner kit.
Toner Kit	B879-1670-T005A	A replacement kit which contains the toner cartridge.





# PRINTER EMULATION CONTROL CODES

The Laser Printer has three resident printer emulation modes:

- LaserJet+
- Diablo 630
- Epson FX-80

The current emulation mode appears on the *SET* key on the operator panel while in the *EMUL* submenu. LaserJet+ is the default emulation. If a non-resident emulation is selected, the controller searches the IC card slots for a match. If no matching emulation is found, LaserJet+ is selected as the default.

When a new emulation mode is selected, the emulation printer's default settings are initialized. If the *SET* key is pressed when the active emulation is used, all downloaded fonts and data is lost. The control codes for the three resident emulation modes are provided as a reference.

## LaserJet+ Control Codes

HP LaserJet+ control codes are listed in the following tables:

<b>Code</b>	<b>Function</b>
BS	Backspace one HMI.
LF	Line feed down one VMI (optional CR).
FF	Form feed to next page (optional CR).
CR	Carriage return to left margin (optional LF).
SI	Shift in. Active primary font.
SO	Shift out. Active secondary font.
ESC	Begins escape sequence.
ESC 9	Clear margins.
ESC =	Half line feed.
ESC E	Reset.
ESC Y	Display functions on.
ESC Z	Display functions off.
ESC z	Self test.
ESC (#@	Primary font default function (# = 0-3).

**LaserJet+ Control Codes Continued**

<b>Code</b>	<b>Function</b>
ESC (#<A thru U>	Primary symbol set (# = 0 - 99).
ESC (#X	Primary font selection (# = ID).
ESC )#@	Secondary font default function (# = 0-3.
ESC )#<A thru U>	Secondary symbol set (# = 0 - 99).
ESC )#X	Secondary Font selection(# = ID).
ESC &a#C	Horizontal cursor positioning . (# = column).
ESC &a#H	Horizontal cursor positioning . (# = 1/720").
ESC &a#L	Left margin (# = column).
ESC &a#M	Right margin(# = column).
ESC &a#R	Vertical cursor positioning (# = row).
ESC &a#V	Vertical cursor position (# = 1/720").
ESC &dD	Auto-underlining On.
ESC &d@	Auto-underlining Off.
ESC &f#S	Cursor stack (# - 0 = Push, 1 - Pop).
ESC &f#X	Macro control (# = 0 thru 10).
ESC &f#Y	Macro ID (# = 0 thru 32767).

**LaserJet+ Control Codes Continued**

Code	Function
ESC &k#G	Line terminator (# = 0 thru 3).
ESC &k#H	HMI (# = 1/729" units).
ESC &k#S	Primary and secondary pitch. (# - 0 = 10 CPI, 2 = 16.66 CPI).
ESC &1#C	VMI (# = 1/48 units).
ESC &1#D	VMI (# = lines per inch).
ESC &1#E	Top margin (= lines).
ESC &1#F	Text length (# = lines).
ESC &1#H	Paper input control (# = 0 thru 3).
ESC &1#L	Perforation skip (# - 0 = off, 1 = on).
ESC &1#O	Orientation (# - 0 = Portrait, 1 = Landscape).
ESC &1#P	Page length (# = lines).
ESC &1#T	Stacker offset toggle (# = 0 - 1).
ESC &1#X	Number of copies (# = 1 thru 99).

**LaserJet+ Control Codes Continued**

<b>Code</b>	<b>Function</b>
ESC &p#X<data>	Transparent print data (# = byte count).
ESC &s#C	Line wrap (# - 0 = on, 1 = off).
ESC (s#H	Stroke weight - primary (# = -7 to + 7).
ESC (s#H	Pitch - primary (# = CPI).
ESC (s#P	Spacing - primary (# - 0 = mono, 1 = prop).
ESC (s#S	Style - primary(# - 0 = upright, I = italic).
ESC (s#T	Typeface - primary (# = 0 thru 255).
ESC (s#V	Point size - primary (# = points).
ESC (s#W <data>	Download font characters. (# = byte count).
ESC )s#B	Stroke weight - secondary (# = -7 to +7).
ESC )s#H	Pitch - secondary (# = CPI).
ESC )s#P	Spacing - secondary. (# - 0 = mono, 1 = prop).
ESC )s#S	Style - secondary. (# - 0 = upright, 1 italic).
ESC )s#T	Typeface - secondary (# = 0 thru 255).

**LaserJet+ Control Codes Continued**

Code	Function
ESC )s#V	Point size - secondary (# = points).
ESC )s#W<data>	Download font header (# = byte count).
ESC *b#W<data>	Transfer raster graphics. (# = byte count).
ESC *c#A	Horizontal rule size. (# = number of dots).
ESC *c#B	Vertical rule size (# = number of dots).
ESC *c#D	Specify font ID (# = 0 thru 32767).
ESC *c#E	Specify character code (# = 0 thru 255).
ESC *c#F	Font management code (# = 0 thru 6).
ESC *c#G	Pattern ID (# - Gray =I-100, Patt.= 1-6).
ESC *C#H	Horizontal rule size (# =I/720).
ESC *c#P	Print rule pattern. (#0 = rule, 2 = gray, 3 =pattern).
ESC *p#X	Cursor-X positioning (# = dots).
ESC *p#Y	Cursor- Y positioning (# = dots).
ESC *r#A	Start raster graphics. (# = margin position).

**LaserJet+ Control Codes Continued**

<b>Code</b>	<b>Function</b>
ESC *rB	End raster graphics.
ESC *t#R	Raster graphics resolution. (# = dots per inch).

## Diablo 630 Control Codes

This section lists the control codes you can use to emulate a Diablo 630 daisy wheel printer.

The following table lists the Diablo 630 emulation codes arranged in ascending ASCII code sequence:

<b>Codes</b>	<b>Hex value</b>	<b>Function</b>
ETX	03	End of transmission . (ETX/ACK mode).
ACK	06	Acknowledge ETX . (ETX/ACK mode).
BS	08	Backspace.
HT	09	Horizontal tab.
LF	0A	Line feed.
VT	0B	Vertical tab.
FF	0C	Form feed.
CR	0D	Carriage return.
SO	0E	Use extended character set.
SI	0F	Use primary character set.



**Diablo 630 Control Codes Continued**

<b>Codes</b>	<b>Hex value</b>	<b>Function</b>
XON	11	Transmit on. (XON/XOFF mode)
XOFF	13	Transmit off. (XON/XOFF mode).
EMn	19	Use extended character set.
GS	1D	Print next character direct.
ESC BS	1B 08	Backspace 1/20.
ESC HT n	1B 09 n	Absolute horizontal tab.
ESC LF	1B 0A	Negative line feed.
ESC VT n	1B 0Bn	Absolute vertical tab.
ESC FF n	1B 0C n	Set number of lines per page.
ESC CR P	1B 0D 50	Reset printer.
ESC DC1 n	1B 11 n	Set HMI offset.

**Diablo 630 Control Codes Continued**

<b>Codes</b>	<b>Hex value</b>	<b>Function</b>
ESC EM n	1B 19 n	Paper Input Section, where n = function number.
		<b>ASCII    HEX    Function</b>
		1        31        Select main cassette.
		2        32        Select optional hopper.
		E        45        Select manual feed.
		R        52        Eject current page if any data in buffer.
ESC SUB	11B 1A 49	Reset printer.
ESC RS n	1B 1E n	Set VMI value.
ESC US n	1B 1F n	Set HMI value.
ESC !	1B 21	Disable auto carriage return.
ESC &	1B 26	Disable bold or shadow print.
ESC , h v	1B 2C h v	Set plot precision . (hyplot mode).
ESC -	1B 2D	Set vertical tab.
ESC . n	1B 2E n	Change plot character (hyplot mode).

**Diablo 630 Control Codes Continued**

<b>Codes</b>	<b>Hex value</b>	<b>Function</b>
ESC 0	1B 30	Set right margin.
ESC I	1B 31	Set horizontal tab.
ESC 2	1B 32	Clear all tabs.
ESC 3	1B 33	Enable graphics mode.
ESC 4	1B 34	Exit hyplot and graphics modes.
ESC 5	1B 35	Disable backward print mode.
ESC 6	1B 36	Enable backward print mode.
ESC 7	1B 37	Enable print suppression.
ESC 8	1B 38	Clear tab at current position.
ESC 9	1B 39	Set left margin.
ESC <	1B 3C	Enable reverse print.
ESC =	1B 3D	Enable auto centering.
ESC >	1B 3E	Disable reverse print mode.
ESC ?	1B 3F	Enable carriage return.

**Diablo 630 Control Codes Continued**

<b>Codes</b>	<b>Hex value</b>	<b>Function</b>
ESC C	1B 43	Clear top and bottom margins.
ESC D	1B 44	Negative half-line feed.
ESC E	1B 45	Enable auto underline.
ESC G	1B 47	Enter hyplot mode, abs. move.
ESC G BEL	1B 47 07	As ESC G, but draw all vectors.
ESC L	1B 4C	Set bottom margin.
ESC M	1B 4D	Enable auto justification.
ESC O	1B 4F	Enable bold print.
ESC P	1B 50	Enable proportional spacing.
ESC Q	1B 51	Disable proportional spacing.
ESC R	1B 52	Disable auto underline.
ESC S	1B 53	Reset HMI value.
ESC T	1B 54	Set top margin.
ESC U	1B 55	Positive half-line feed.
ESC V	1B 56	Enter hyplot mode rel. move.
ESC V BEL	1B 56 07	As V, but draw all vectors.
ESC W	1B 57	Enable shadow print.



## Epson FX-80 Control Codes

Epson emulation is useful when using software packages that do not support the printer's built-in emulations. Almost every IBM PC software package provides support for an Epson printer of some kind.

When you configure the software for your system, select Epson FX-80 as the output device. This will almost always give you the output you want. Should it cause any problems, try selecting the Epson MX-80 or IBM Graphics Printer, (but not the Proprinter), instead. The Epson FX-80 Control Codes are listed below and on the following pages.

Codes	Hex Value	Function
BS	08	Backspaces one character.
HT	09	Performs horizontal tabs.
LF	0A	Performs line feed.
VT	0B	Performs vertical tab.
FF	0C	Form feed.
CF	0D	Carriage return.
SO	0E	Selects double-width printing.
SI	0F	Selects compressed printing.
DC2	12	Cancel compressed printing.
DC4	14	Cancel double-width printing.

**Epson FX-80 Control Codes Continued**

<b>Codes</b>	<b>Hex Value</b>	<b>Function</b>												
CAN	18	Cancels data in the print buffer.												
ESC	1B	Escape - used with all subsequent codes.												
ESC SO	1B 0E	Selects double-width printing.												
ESC SI	1B 0F	Selects compressed printing.												
ESC !	1B 21	Selects print mode. Format: ESC ! n where n is print mode. Calculate by adding the values of appropriate modes together:  <table border="0" style="margin-left: 40px;"> <tr> <td>128</td> <td>Underline</td> </tr> <tr> <td>64</td> <td>Italic</td> </tr> <tr> <td>2</td> <td>Double-width</td> </tr> <tr> <td>16</td> <td>Double-strike</td> </tr> <tr> <td>8</td> <td>Emphasized</td> </tr> <tr> <td>4</td> <td>Compressed</td> </tr> </table>	128	Underline	64	Italic	2	Double-width	16	Double-strike	8	Emphasized	4	Compressed
128	Underline													
64	Italic													
2	Double-width													
16	Double-strike													
8	Emphasized													
4	Compressed													
ESC #	1B 23	Cancels ESC = and ESC >. Printer accepts 7- and 8-bit data without modification.												

## Epson FX-80 Control Codes Continued

Codes	Hex Value	Function														
ESC *	1B 2A	<p>Selects graphics mode.            Format: ESC* m n1 n2, where            m is graphics mode (0 to 6).            N1 is the number of cols. if &lt;256            (n2 is 0). (n2 * 256)+ n1 is the            number of cols. if &gt;256.            Graphics mode values are:</p> <table border="0"> <tr><td>0</td><td>Single density (60 dpi)</td></tr> <tr><td>1</td><td>Low speed double density (120 dpi)</td></tr> <tr><td>2</td><td>High-speed double density (120 dpi)</td></tr> <tr><td>3</td><td>Quadruple-density (240 dpi)</td></tr> <tr><td>4</td><td>CRT graphics mode (80 dpi)</td></tr> <tr><td>5</td><td>Plotter mode (72 dpi)</td></tr> <tr><td>6</td><td>CTR graphics mode II (90 dpi)</td></tr> </table>	0	Single density (60 dpi)	1	Low speed double density (120 dpi)	2	High-speed double density (120 dpi)	3	Quadruple-density (240 dpi)	4	CRT graphics mode (80 dpi)	5	Plotter mode (72 dpi)	6	CTR graphics mode II (90 dpi)
0	Single density (60 dpi)															
1	Low speed double density (120 dpi)															
2	High-speed double density (120 dpi)															
3	Quadruple-density (240 dpi)															
4	CRT graphics mode (80 dpi)															
5	Plotter mode (72 dpi)															
6	CTR graphics mode II (90 dpi)															
ESC -	1B 2D	<p>Sets auto underline on or off.            Format: ESC - n, where n is</p> <table border="0"> <tr><td>0</td><td>- off</td></tr> <tr><td>1</td><td>- on</td></tr> </table>	0	- off	1	- on										
0	- off															
1	- on															
ESC/n	1B 2F n	Activates VFU Channel, where n is the number of the channel														
ESC 0	1B 30	Sets 8 lines per inch														
ESC 1	1B 31	Sets line spacing to 2/72 in.														
ESC 2	1B 32	Sets 6 line per inch.														



**Epson FX-80 Control Codes Continued**

<b>Codes</b>	<b>Hex Value</b>	<b>Function</b>
ESC 3	1B 33	Sets line space to n/216 in. Format: ESC 3 n, where n is a number from 0 to 255.
ESC 6	1B 36	Enables ASCII codes 128-159 & 255 (italics).
ESC 7	1B 37	Disables ASCII codes 128-159 & 255 (italics).
ESC <	1B 3C	Turns on unidirectional (left to right) mode for one line.
ESC =	1B 3D	Sets MSB (bit 7) to 0.
ESC >	1B 3E	Sets MSB (bit 7) to 1.
ESC ?	1B 3F	Redefines ESC K,L,Y, or Z to set the graphics mode to other than its normal function. Format: ESC ? X n, where X is K,L,Y, or Z and n is the new mode (0 to 6).
ESC @	1B 40	Initializes the printer.
ESC B	1B 41	Sets line spacing to n/72 in. Format: Esc A n, where n is a number from 0 to 255.
ESC B	1B 42	Sets up to 16 vertical tabs. Format: ESC B n [n [...n]] 0 N is the line number, from 1 to 255.

**Epson FX-80 Control Codes Continued**

Codes	Hex Value	Function
ESC C	1B 43	Sets page length. Two formats: ESC C n, which sets length to n lines, where n is a number from 1 to 127 (default is 66). ESC C C0 n sets length to n inches, where n is a number from 1 to 22.
ESC D	1B 44	Sets up to 32 horizontal tabs. Format: ESC D n[n[...]] 0, where n is the character position.
ESC E	1B 45	Sets emphasized print mode.
ESC F	1B 46	Cancels emphasized print mode.
ESC G	1B 47	Sets double-strike print mode.
ESC H	1B 48	Cancels double-strike mode.
ESC J	1B 4A	Performs line feed of n/216 in. Format: ESC J n, where n is a number from 0 to 255.
ESC K	1B 4B	Sets single-density graphics mode printing 480 dots per 8-inch line (= 60 dpi). Format: ESC K n1 n2, where n1 is no. of cols. If <256 (n2 is 0) (n2 * 256) = n1 is no. of cols if >256.

**Epson FX-80 Control Codes Continued**

<b>Codes</b>	<b>Hex Value</b>	<b>Function</b>
ESC L	1B 4C	Sets double-density graphics mode. Prints 960 dots per 8-inch line (= 120 dpi). Format: ESC L n1 n2, where n1 is the number of cols. If < 256 (n2 is 0). (n2 * 256) = n1 is the number of cols. if > 256.
ESC M	1B 4D	Sets Elite-size characters. A 12-cpi version of Courier.
ESC M	1B 4E	Sets skip-over-perforation, reducing page length by n lines. Format: ESC N n, where 1 <= n <= 127.
ESC N	1B 4F	Cancel skip-over-perforation.
ESC P	1B 50	Cancel ESC M.
ESC Q	1B 51	Sets right margin. Format: ESC Q n, where n is right margin character position. It must be a number from 1 to maximum in current font spacing.
ESC R n	1B 52 n	Select International Char Set. Format: n = set #.

**Epson FX-80 Control Codes Continued**

Codes	Hex Value	Function
ESC S	1B 53	Turns on superscript or subscript. Format: ESC S n, where n is  0 - superscript) 1 - subscript)
ESC T	1B 54	Cancels superscript or subscript printing.
ESC U	1B 55	Sets unidirectional  0 - left to right 1 - on
ESC W	1B 57	Turns double-width characters on or off. Format: ESC W n, where n is  0 - off 1 - on
ESC Y	1B 59	Sets high-speed double-density graphics mode. Same format as ESC L.
ESC Z	1B 5A	Sets quadruple-density graphics mode, 1920 dots per 8-inch line (240 dpi). Format: ESC Z n1 n2, where n1 is the number of cols. if <256 If >256,.(n256x256)+n1 is the number of cols.

**Epson FX-80 Control Codes Continued**

<b>Codes</b>	<b>Hex Value</b>	<b>Function</b>
ESC b n m	1B 62 n m	VFU position setting. (0<=n<=7) (1<=m<1<=m<16). Sets the VFU (Vertical Format Unit) position for channel n. For details of VFU, refer to ESC / code in FX-80 Technical Reference Manual. Specified Tab positions must be terminated with a null (0). VFU has 8 channels (0 to 7). Each channel up to 16 positions can be set within the length. Channel is set to 0 at start up.
ESC 1	1B 6C	Sets left margin. Format: ESC 1 n, where n is character position of left margin.
ESC p	1B 70	Selects proportional spacing.

## Extended Commands

The Fujitsu extended command set augments the LaserJet+ font and character control features and allows them to be used in conjunction with the Diablo 630 and Epson FX-80 resident emulations.

Commands can only be used individually. They are as follows:

Code	Hex Value	Function
Esc Bel	1B 7	Activate extended command control. Commands are entered during the current emulation. The LCD panel displays <i>Extended CMDS</i> to remind users that they are in this mode. After returning to current emulation, the normal idling message reappears.

**Note:**

The controller will regard the following escape sequences as the extended commands until it receives either the command to return to Emulation (ESC X) or the Select Emulation escape sequence. The current emulation environment is preserved for a possible return.

ESC X	1B 58	Switch Back to Emulation Mode: Exits the Extended Command Set and returns to the current active emulation. The current emulation environment is restored with the exception of items changed by extended commands.
-------	-------	--

**Extended Commands Continued**

Codes	Hex Value	Function
Esc + f#E	1B 2B 66 # 45	Select Emulation: Changes to another emulation mode without using the front panel. # = desired emulation's ID.

The controller prints the current page and initializes to the default environment for the new emulation, even if requested emulation is the current one.

If the requested emulation is not installed, no action is taken. *INVALID EMUL*, is displayed approximately 5 seconds. The value field specifies the new emulation as follows:

ASCII	Hex	Emulation
10	31,30	Diablo 630 API/ECS
11	31,31	Qume Sprint 11*
20	32,30	IBM Graphic Printer
21	32,31	IBM Proprinter*
22	32,32	Epson FX-80
23	32,33	Epson FX-80*
42	34,31	HP LaserJet+
50	35,30	HPGL (HP-7475-A*)

\*All these modes are supported by the optional emulation card.

## Extended Commands Continued

Codes	Hex Value	Function																					
Esc&1#H	1B 26 6C # 48	Paper Feed Selection. Controls paper input. The value field specifies the paper feed as follows:																					
		<table border="1"> <thead> <tr> <th>ASCII</th> <th>Hex</th> <th>Emulation</th> </tr> </thead> <tbody> <tr> <td>0</td> <td>0</td> <td>Eject the current page</td> </tr> <tr> <td>1</td> <td>31</td> <td>Selects main paper cassette.</td> </tr> <tr> <td>2</td> <td>32</td> <td>Select manual feed.</td> </tr> <tr> <td>3</td> <td>33</td> <td>Not used.</td> </tr> <tr> <td>4</td> <td>34</td> <td>Select large capacity hopper.</td> </tr> <tr> <td>5</td> <td>35</td> <td>Enable selection of main or secondary cassette. (If current cassette runs out, autoswitch to other cassette normally occurs.</td> </tr> </tbody> </table>	ASCII	Hex	Emulation	0	0	Eject the current page	1	31	Selects main paper cassette.	2	32	Select manual feed.	3	33	Not used.	4	34	Select large capacity hopper.	5	35	Enable selection of main or secondary cassette. (If current cassette runs out, autoswitch to other cassette normally occurs.
ASCII	Hex	Emulation																					
0	0	Eject the current page																					
1	31	Selects main paper cassette.																					
2	32	Select manual feed.																					
3	33	Not used.																					
4	34	Select large capacity hopper.																					
5	35	Enable selection of main or secondary cassette. (If current cassette runs out, autoswitch to other cassette normally occurs.																					

**Note:**

If the second cassette or the large capacity hopper are not installed, ASCII values of 4 and 5 are ignored. If the current feed method is equal to the requested value, the command will be ignored. The system default is the main paper cassette or NV Ram setup selection. If the command is received in the middle of page processing, the current page is printed and ejected. The command takes effect after ejection.



**Extended Commands Continued**

Codes	Hex Value	Function
Esc O	1B 4F	Stacker Offset. Switches stacker output positions. Command is acceptable at any point on the current page. Command is ignored if stacker is not installed.
Esc & 1#0	1B 26 6C # 0	Page Orientation. Selects page orientation in 90 degree increments. When received, margins, HMI, VMI and cursor location are set to default values. If the currently selected font does not match the new orientation and does not already exist, then it is rotated. If the current orientation matches the requested one, the command is ignored. Value field specifies orientation as follows:
	ASCII Hex	Emulation
	0 30	Portrait (0 degrees)
	1 31	Landscape-Left (27 degrees)

## Extended Commands Continued

Codes	Hex Value	Function																																																									
Esc *c#M	1B 2A 63 # 4C	Character Manipulation. Change value field to incorporate multiple selections of special effects. # =[[width] [height] [bold] [slant] [rotate]...]																																																									
		<table border="1"> <thead> <tr> <th>ASCII</th> <th>Hex</th> <th>Meaning</th> </tr> </thead> <tbody> <tr> <td colspan="3" style="text-align: center;">Width</td> </tr> <tr> <td>0</td> <td>30</td> <td>Normal</td> </tr> <tr> <td>1</td> <td>31</td> <td>Double Width</td> </tr> <tr> <td>2</td> <td>32</td> <td>Half Width</td> </tr> <tr> <td>9</td> <td>39</td> <td>Unchanged</td> </tr> <tr> <td colspan="3" style="text-align: center;">Height</td> </tr> <tr> <td>0</td> <td>30</td> <td>Normal</td> </tr> <tr> <td>1</td> <td>31</td> <td>Double Height</td> </tr> <tr> <td>2</td> <td>32</td> <td>Half Height</td> </tr> <tr> <td>9</td> <td>39</td> <td>Unchanged</td> </tr> <tr> <td colspan="3" style="text-align: center;">Bold</td> </tr> <tr> <td>0</td> <td>30</td> <td>Normal</td> </tr> <tr> <td>1</td> <td>31</td> <td>Bold</td> </tr> <tr> <td>9</td> <td>39</td> <td>Unchanged</td> </tr> <tr> <td colspan="3" style="text-align: center;">Slant</td> </tr> <tr> <td>0</td> <td>30</td> <td>Normal</td> </tr> <tr> <td>1</td> <td>31</td> <td>Not supported</td> </tr> <tr> <td>9</td> <td>39</td> <td>Unchanged</td> </tr> </tbody> </table>	ASCII	Hex	Meaning	Width			0	30	Normal	1	31	Double Width	2	32	Half Width	9	39	Unchanged	Height			0	30	Normal	1	31	Double Height	2	32	Half Height	9	39	Unchanged	Bold			0	30	Normal	1	31	Bold	9	39	Unchanged	Slant			0	30	Normal	1	31	Not supported	9	39	Unchanged
ASCII	Hex	Meaning																																																									
Width																																																											
0	30	Normal																																																									
1	31	Double Width																																																									
2	32	Half Width																																																									
9	39	Unchanged																																																									
Height																																																											
0	30	Normal																																																									
1	31	Double Height																																																									
2	32	Half Height																																																									
9	39	Unchanged																																																									
Bold																																																											
0	30	Normal																																																									
1	31	Bold																																																									
9	39	Unchanged																																																									
Slant																																																											
0	30	Normal																																																									
1	31	Not supported																																																									
9	39	Unchanged																																																									

**Extended Commands Continued**

Codes	Hex Value	Function
		ASCII Hex    Meaning
		Reverse
	0	30    Normal
	1	31    Not supported
	9	39    Unchanged
		Rotate
	0	30    0 degree
	1	31    270 degree clockwise
	2	32    180 degree (not supported)
	3	33    90 degree (not supported)
	9	39    Unchanged

**Note:**  
Fields of unsupported functions are ignored.

Esc &2#W	1B 26 6C # 57	<p><b>Copy Range:</b> Specifies effective range of copy function. Value field specifies the number of pages to copy from the current page and can range from 1 to 255. Default value is 1. If value is out of range, the command is ignored. When the value is set to 0, the range is infinite. This command is only effective when the Copy Start command value is greater than 1.</p>
----------	---------------	---

**Extended Commands Continued**

Codes	Hex Value	Function
Esc &1#X	1B 26 6C # 58	Copy Start. Prints multiple copies of a page. Takes effect upon receipt and remains in effect until changed or until printer is reset. the value specifies the number of copies to make. Its range is 1 to 255. If the value is out of range, the command is ignored. Its default value is 1.
Esc Z	1B 5A	Self Test. The following items are checked during the printer self test:  <ol style="list-style-type: none"><li>1 LCD Display Panel</li><li>2 Engine Status</li><li>3 Printing capability</li></ol>
<b>Note:</b> Each error will be indicated by a unique message display on the control panel.		
Esc *c#D	1B 26 # 6C 44	Specify Font ID. Assigns user ID number. Default value is zero with a range of 0 to 32767. Maximum number of fonts allowable at one time is 100.

**Extended Commands Continued**

Codes	Hex Value	Function
Esc *c#E	1B 26 6C # 45	Specify character code. Specifies decimal ASCII value of character. Used in font downloading and font/character deletion. Default value is zero and range is 0 to 255. If specified value is out of range, the command is ignored.
Esc )s#W	Font Descriptor 1B 29 73 # 57 [data]	Create Font, where [data] is the data in following HP header and # is the number of bytes in HP header to follow. Builds a font header for the specified font ID value. Definition and command sequence is the same as HP LaserJet+ format. This is the first step in downloading a font.

**Extended Commands Continued**

Codes	Hex Value	Function																								
Esc *c#F+	1B 2A 63 # 46	Font and Char Control. Definition and command sequence is same as HP LaserJet+ format. Performs one of the following:																								
		<table border="1"> <thead> <tr> <th>ASCII</th> <th>Hex</th> <th>Emulation</th> </tr> </thead> <tbody> <tr> <td>0</td> <td>30</td> <td>Delete all fonts</td> </tr> <tr> <td>1</td> <td>31</td> <td>Delete all temp font</td> </tr> <tr> <td>2</td> <td>32</td> <td>Delete specified fon</td> </tr> <tr> <td>3</td> <td>33</td> <td>Delete char code frc last specified font</td> </tr> <tr> <td>4</td> <td>34</td> <td>Make font temporar</td> </tr> <tr> <td>5</td> <td>35</td> <td>Make font permane (last specified font)</td> </tr> <tr> <td>6</td> <td>36</td> <td>Copy/Assign font (last specified font)</td> </tr> </tbody> </table>	ASCII	Hex	Emulation	0	30	Delete all fonts	1	31	Delete all temp font	2	32	Delete specified fon	3	33	Delete char code frc last specified font	4	34	Make font temporar	5	35	Make font permane (last specified font)	6	36	Copy/Assign font (last specified font)
ASCII	Hex	Emulation																								
0	30	Delete all fonts																								
1	31	Delete all temp font																								
2	32	Delete specified fon																								
3	33	Delete char code frc last specified font																								
4	34	Make font temporar																								
5	35	Make font permane (last specified font)																								
6	36	Copy/Assign font (last specified font)																								

**Extended Commands Continued**

<b>Code</b>	Esc (s#W
<b>Hex Value</b>	Character Descriptor Raster Data 1B 28 73 # [data]
<b>Function</b>	Download character: Where character descriptor and raster data follow the sequence and # = the number of bytes to except (including descriptor). Downloads a character to last specified ID font and at last specified character code value. Command sequence and definition is same as HP LaserJet+format.
<b>Code</b>	Esc(f#i#o#v#h#;
<b>Hex Value</b>	1B 28 66 [Internal ID] 69 [Orientation]6F[Point] 76 [Pitch] 68 [Symbol] 3B
<b>Function</b>	Select Font via Internal ID, Orient, Point, Pitch, and Symbol. The Select Font is based on the above attributes with priorities aligned as above. Must be terminated by a semi-colon.

## Extended Commands Continued

**Code** Esc(#X

**Hex Value** 1B 78 # 58

**Function** Shift In/Make Active. Makes the font which matches the last specified font ID an active font. The Internal ID is a 16-bit code in the following format:

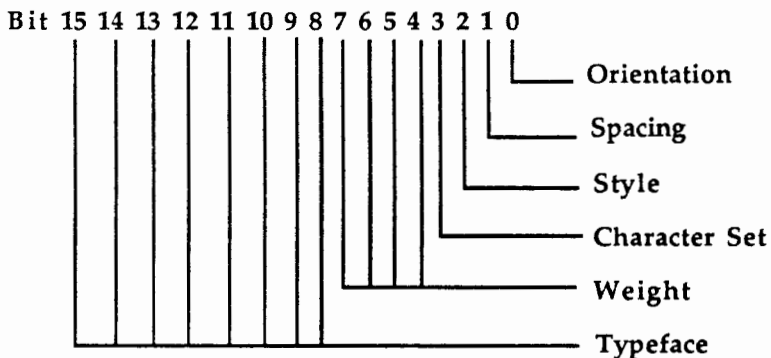

Bits	Function	Value
0	Orientation	0 - Portrait 1 - Landscape
1	Spacing	0 - Fixed 1 - Proportional
2	Style	0 - Upright 1 - Italic
3	Character Set	0 - 128 Characters 1 - 256 Characters



**Extended Commands Continued**

<b>Bits</b>	<b>Function</b>	<b>Value</b>
4 to 7	Weight*	-1 to -7 = Light 0 = Medium 1 to 7 = Bold
8 to 15	Typeface	0 - Line Printer 1 - Pica 2 - Elite 3 - Courier 4 - Helvetica 5 - Times Roman 6 - Gothic 7 - Script 8 - Prestige

\* 4-bit two's complement

## Raster Graphics (HP)

Codes	Hex Value	Function
Esc *t#R	1B 2A 74 # 52	Specify Resolution: Specifies raster graphics resolution in dots per inch. Definition and command sequence is the same as the HP LaserJet+ format. # = Graphics resolution value.
Esc *r#A	1B 2A 72 # 41	Start Raster Graphics, where # = cursor position. Specifies cursor starting position as raster graphic left margin. Definition and command sequence is the same as HP LaserJet+ format.
Esc *b#W	[raster data] 1B 2A 62 #57	Transfer Raster Graphics, where raster data follows sequence and # = specifies number of bytes of data in this line. Notifies printer to expect specific number of bytes of data and transfers graphics data to printer. Definition and command sequence are the same as HP LaserJet+ format.
Esc *rB	1B 2A 72 42	End Raster Graphics. Informs printer that raster data transfer is complete. Definition and command sequence is the same as HP LaserJet+ format.

## Status and Error Messages

Message	Meaning
ONLINE	Online mode.
OFFLINE	Offline mode.
SELFTEST	Selftest being executed.
RAM ERROR	RAM memory error, selftest message.
ROM ERROR	ROM memory error, selftest message.
I/F DATA ERROR	Communication data error. Possible problem with parity, overrun, framing, etc.
PB OVERFLOW	Page buffer overflow.
COVER OPEN	A cover is open.
TONER EMPTY	The toner bottle is empty. Replace with a new toner bottle.
COLLECTOR OUT	Toner collection bottle is not installed.
HOPPER EMPTY	Large paper hopper not installed.
STACKER OFF	Paper stacker not installed.
STACKER FULL	Paper stacker is full.

Message	Meaning
USE CASSETTE	Occurs when paper is input during cassette mode.
PAPER JAM 0	Manual feed jam.
PAPER JAM 1	Paper jam at location 1.
PAPER JAM 2	Paper jam at location 2.
PAPER JAM 3	Paper jam at location 3.
PAPER EMPTY	There is no paper in the cassette or it is not installed.
HOPPER EMPTY	Large paper hopper is empty.
CHK PAPER SIZE	Paper size does not match cassette size.
MANUAL FEED	Fuser malfunction.
E0 FUSING	Manual feed mode, input paper
E1 FUSING	Laser power abnormal.
E2 FUSING	Beam detect signal error.
E3 FUSING	Scanning motor malfunction.
E4 FUSING	Main motor malfunction.
E5 FUSING	Mechanism malfunction. Illegal video I/F command.

## **Printer Options**

<b>Item</b>	<b>Part Number</b>	<b>Description</b>
Large Capacity Hopper	B020-7310-B001A	Modular design with 1000 sheet capacity. Doubles as a printer stand. Perfect for stand alone work station environment.
Face Down Stacker		Input feeder that accommodates forward collated documents.
Paper Cassette Module	B020-7280-V154	Letter, 8.5 x 11. 250 sheet capacity.
Paper Cassette	B020-7280-V155	Legal, 8.5 x 14 250 sheet capacity.
Paper Cassette		A4, 8.3 x 11.7 250 sheet capacity.
Paper Cassette		B4, 10.1 x 14.3 250 sheet capacity.
Dual Bin Sheet Feeder		Adjustable trays. 250 sheet capacity per bin.



## Pinouts

**TABLE G.1**  
CENTRONICS PARALLEL INTERFACE SIGNAL  
DEFINITIONS

Name	Signal Pin	Return Pin	Direction
/DSTB	1	19	IN

### SIGNAL DEFINITION

Low level pulse from the host, used as a synchronizing clock for reading data. /ACK has been returned before issuing the next /DSTB. /DSTB is ignored if Busy is high.

DATA 1	2	20	IN
DATA 2	3	21	IN
DATA 3	4	22	IN
DATA 4	5	23	IN
DATA 5	6	24	IN
DATA 6	7	25	IN
DATA 7	8	26	IN
DATA 8	9	27	IN

### SIGNAL DEFINITION

The data lines input from the host. High level is binary 1 and low level is binary 0. DATA 8 is the most significant bit (MSB). For 7-bit codes, DATA 8 can be ignored.

/ACK	10	28	OUT
------	----	----	-----

### SIGNAL DEFINITION

Low level pulse from the printer, used to indicate that the printer can receive data.

BUSY	11	29	OUT
------	----	----	-----

Name	Signal Pin	Return Pin	Direction
------	------------	------------	-----------

**SIGNAL DEFINITION**

High level indicates printer is not ready to receive data. This signal is issued in one of the following cases:

- Input buffer full
- Error conditions
- Off-Line state (including test and set up modes).

PE	12		OUT
----	----	--	-----

**SIGNAL DEFINITION**

High level indicates out of paper.

SLCT	13		OUT
------	----	--	-----

**SIGNAL DEFINITION**

High level indicates on-line states. This signal goes off in one of the following cases:

- Error conditions
- Press the On-Line switch in on-state
- Off -Line state (including test and set up modes).

SG	14		
(Signal Ground)			

**SIGNAL DEFINITION**

Signal ground level (0 V)

(Reserved)	15		
------------	----	--	--

SG	16		
(Signal Ground)			

**SIGNAL DEFINITION**

Signal ground level (0 V)



Name	Signal Pin	Return Pin	Direction
------	------------	------------	-----------

FG (Frame Ground)	17		
----------------------	----	--	--

**SIGNAL DEFINITION**  
Frame ground line

+5V	18		OUT
-----	----	--	-----

**SIGNAL DEFINITION**  
Directly connect to +5V volt on the printer.

/INPRIME	31	30	IN
----------	----	----	----

**SIGNAL DEFINITION**  
Low level initializes the printer. When this signal goes on, the printer clears the data buffers.

/ERROR	32		OUT
--------	----	--	-----

**SIGNAL DEFINITION**  
Low level indicates the printer is in error states.

(Reserved)	33 - 35		
------------	---------	--	--

/SLCT IN	36		IN
----------	----	--	----

**SIGNAL DEFINITION**  
Low level signal used for placing the printer in On-Line.

**TABLE G.2**  
**RS232C SERIAL INTERFACE NAMES AND DEFINITIONS**

SIGNAL NAME	SIGNAL PIN #	DIRCT
-------------	-----------------	-------

FG (Frame Ground)	1 ---	
----------------------	-------	--

**SIGNAL DEFINITION**

Protective Ground

This circuit is connected internally to the printer's mainframe.

TD (Transmittal Data)	2	OUT
--------------------------	---	-----

**SIGNAL DEFINITION**

The printer can transmit data to the host through this circuit only when the following signals are ON:

--- RTS, CTS, DSR, DTR

RD (Receive Data)	3	IN
----------------------	---	----

**SIGNAL DEFINITION**

Signals on this circuit represent commands and/or print data sent to the printer for execution. This circuit is held in marking (low) while CD is off.

RTS (Request to Send)	4	OUT
--------------------------	---	-----

**SIGNAL DEFINITION**

When this signal is on (low), the printer is requesting the host to send data or is transmitting data to the host.

After this signal is turned on and the CTS goes on, the printer begins transmitting data.

<b>SIGNAL NAME</b>	<b>SIGNAL PIN #</b>	<b>DIRCT</b>
CTS (Clear to Send)	5	IN

**SIGNAL DEFINITION**

This signal is turned on when the host confirms that the RTS is 0 and data from the printer can be received.

DSR (Data Set Ready)	6	IN
-------------------------	---	----

**SIGNAL DEFINITION**

When this signal is on, the host is ready to transmit data. When this signal is off, the printer ignores data on RD line.

SG (Signal Ground)	7	---
-----------------------	---	-----

**SIGNAL DEFINITION**

This line is a signal ground and provides a common reference potential for all interface lines.

(Reserved)	8-19	
DTR (Data Terminal Ready)	20	OUT

**SIGNAL DEFINITION**

When this signal is on, the host can transmit data to the printer. When the power is turned on and the printer logic is cleared, DTR is set on and remains on while the printer is ready for data communication. When this signal is off, the host is disconnected from the communication channel after data transmission.

(Reserved)	21-25	
------------	-------	--



# INDEX

## A-D

- arrow keys 4-9
- BITMAP 4-46
- carrier station 7-2
- Centronics 3-13
- check indicator 1-10
- clear /print key 1-8, 4-8
- control codes 5-5. D-1
- control panel 4-1
  - arrow keys 4-9
  - bitmap 4-46
  - clear/print key 4-8
  - error reset key 4-7
  - layout 4-5
  - set key 4-9
  - setup keys 4-6

## E - G

- EMUL (Emulations) 4-36
- environment 2-1
- environment settings 4-23
- error messages 8-5, E-1
- error reset key 1-8, 4-7
- EXIT 4-28
- face down stacker 1-1, 3-14
- font card 4-47
- Font Card Tutorial 4-47
- fonts 1-1, 4-23, 4-40
  - changing 6-1
- Format submenu 4-32

**H - L**

- HEXDUMP 4-28
- IC cards 1-13
- indicator lights 4-6
- installation 3-1
  - developer unit 3-6
  - face down stacker 3-12
  - fonts 6-2
  - IC cards 3-16
  - large capacity hopper 3-16
  - output tray 3-15
  - paper 3-10
  - photoconductor drum 3-2
  - power cable 3-14
- Interface Menu 4-30
  - Cent 4-30
  - RS232C 4-30
- large capacity hopper 1-17, 3-18
- Laser Printer parts 1-3, 2-7

**M - O**

- macro 4-24
- main cassette 4-38
- Main Menu 4-21
- main menu options 1-11
- maintenance 7-1
  - oil felt 7-8
  - paper 7-9
  - photoconductor drum 7-10
  - toner bottle 7-7
  - toner cartridge 7-4
- manual feed 4-38
- menus 4-13
- oil felt, replacing 7-8
- online indicator 1-10
- online set key 1-8
- Operator Panel 1-6

**P - R**

- Page submenu 4-42
- page orientation 5-1
- Paper Menu 4-42
- paper 1-1
- paper cassette 1-15, 3-10
- paper jams 7-9, 8-2
- paper settings 4-23
- Paper submenu 4-38
- photoconductor drum 1-5, 7-10
- power indicator 1-11
- physical specifications A-1
- pinouts specifications G-1
- power port 1-12
- print area 5-3
- print quality 8-4
- Printer Controller 1-5
- printer emulation 5-5
- printer mode 4-5, 4-11
- printer module 1-4
- printing 5-1
- printing keys 1-8
- PROTO (Protocol) 4-34

**S - Z**

- second cassette 4-39
- selftest 4-27
- set key 4-9
- Setup Keys 1-7, 4-6
- Setup Mode 1-7, 4-5, 4-12
- setup menus 1-11
- status 1-11
- supplies and accessories, C-1
- toner bottle, replacing 7-7
- toner cartridge, replacing 7-4
- unpacking 2-2

